



2022-2024 CHRYSLER PACIFICA HYBRID

# EMERGENCY RESPONSE GUIDE



Gasoline-Electric Hybrid Vehicle

Revision 2023-06-20-01

This brochure is a publication of FCA US LLC. All product illustrations and specifications are based upon current information at the time of publication approval. FCA US LLC reserves the right to make changes from time to time, without notice or obligation, in prices, specifications, colors and materials, and to change or discontinue models, which are considered necessary to the purpose of product improvement or for reason of design and/or marketing.

# CONTENTS

1. Identification / recognition	Page 3
2. Immobilization / stabilisation / lifting	Page 6
3. Disable direct hazards / safety regulations	Page 8
4. Access to the occupants	Page 14
5. Stored energy / liquids / gases / solids	Page 18
6. In case of fire	Page 22
7. In case of submersion	Page 23
8. Towing / transportation / storage (2 <sup>nd</sup> Responder Guidance)	Page 24
9. Important additional information	Page 27
10. Explanation of pictograms used	Page 29

The Pacifica Hybrid can be identified by the following external indications:



A charge port door with the “e” leaf logo, which is located at the driver-side fender panel.



Unique badging on lift gate on the passenger-side rear.

The Pacifica Hybrid can be identified by the following internal indication:



The left dash gauge is a power meter.



Charge status indicator on top of the dash panel. Only illuminated when plugged in and charging.

The Pacifica Hybrid can be identified by the following engine compartment indication:



The engine cover is unique as shown.

Chrysler Pacifica vehicles equipped with these features are hybrid-electric vehicles and utilize a high voltage lithium-ion power source in addition to liquid fossil fuel for propulsion energy. All practices and precautions for working with hybrid-electric vehicles should be followed when responding to an incident involving one of these vehicles.



The Chrysler Pacifica Hybrid employs electronic shift controls. With 12-volt power active (ignition set to “RUN” or “ACC”), the transmission can be shifted between any mode including PARK and NEUTRAL, and the PARKING BRAKE can be engaged or disengaged.

For rescue and firefighting activities, if safe to do so, put the vehicle into PARK and engage the PARKING BRAKE.

Shifting in and out of PARK and actuating the PARKING BRAKE

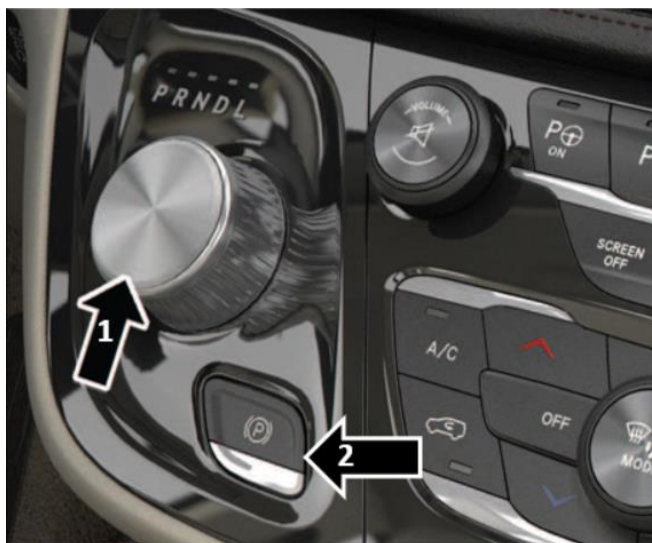

- This vehicle uses an electronic shift control (1) for the automatic transmission. To shift the vehicle to PARK, rotate the knob counter clockwise until it stops.
- To place the vehicle in NEUTRAL, press on the brake, then rotate the knob clockwise from park 2 clicks until the bar LED above “N is lit.
- The Electric Parking Brake control (2) is below the shifter and is a push button type. The LED illuminates when the PARKING BRAKE is set.

Note: 12V power must be activated to shift in and out of PARK or to change the PARKING BRAKE state.



**WARNING:** In rare instances, rotation of the drive wheels may result in the generation of high voltage electrical energy external to the high voltage battery isolation device, and may also trigger a propulsion system response. Place in PARK to prevent rotation if able. DO NOT PUSH.

In addition to the use of wheel chocks, if deemed appropriate by incident command, the Chrysler Pacifica Hybrid may be lifted off its wheels to further stabilize or gain access. This lifting should be accomplished by supporting only at the lift points along the frame rail indicated by arrows shown below:

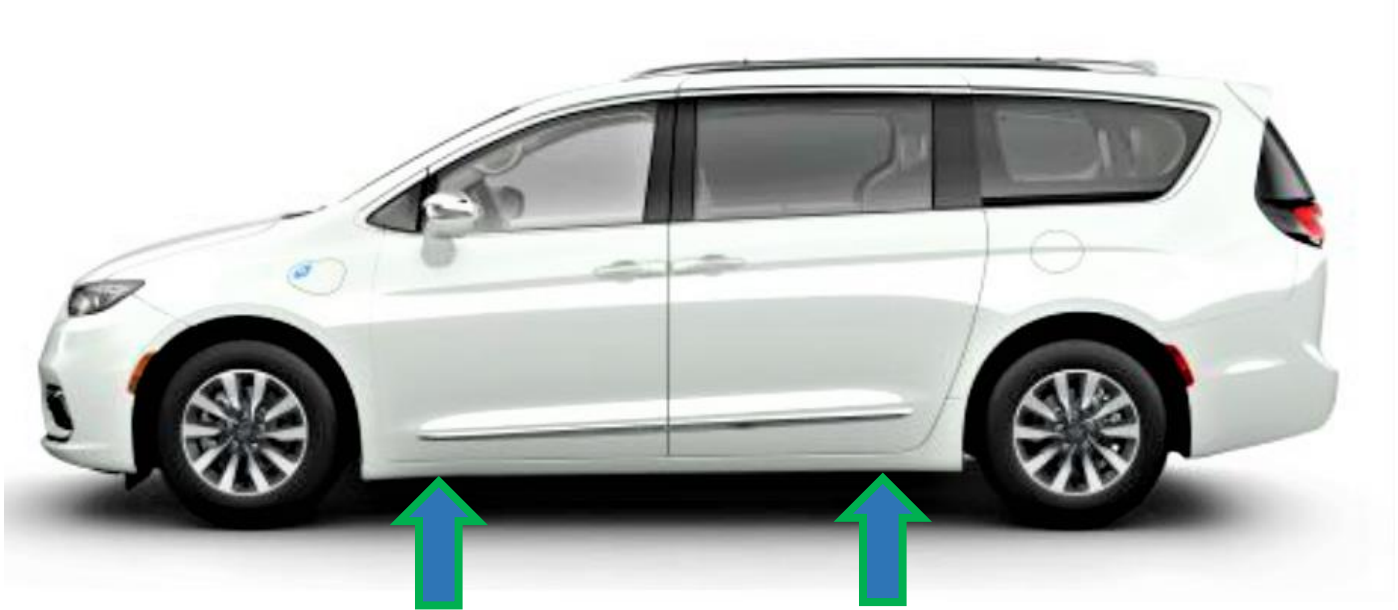

Determination of actual lift points must be made by incident command based on the unique situational factors such as possible relocation of the hazards illustrated on the ensuing pages as a result of impact events. These are only recommendations.

Chrysler Pacifica Hybrid – RESCUE SHEET

# Chrysler Pacifica Hybrid

## PHEV - 5 doors

### 2022-11

5.

5.

Note: The Rescue Sheet depicts a LHD vehicle (as allowed under the ISO 17840-1). All components (other than steering wheel and passenger airbag) are located in the same position in the Aust/NZ RHD model.

ISO 17840-1 PICTOGRAMS			OCCUPANT/CURTIAN/BOLSTER AIR BAG AND INFLATOR		AIR BAG INFLATOR		SEATBELT PRETENSIONER		AUTOMATIC ROLL-OVER PROTECTIO	
		PEDESTRIAN PROTECTION DEVICE		GAS STRUT, PRE-LOADED SPRING, BELT RETRACTOR		RESTRAINT SYSTEM CONTROL MODULE		HIGH STRENGTH ZONE		ZONE REQUIRING SPECIAL ATTENTION
		LOW VOLTAGE BATTERY		LOW VOLTAGE ULTRA-CAPACITOR		FUEL TANK		COMPRESSED GAS TANK		SAFETY VALVE COMPRESSED GAS
		HIGH VOLTAGE BATTERY PACK		HIGH VOLTAGE CABLE		HIGH VOLTAGE DISCONNECT		LOW VOLTAGE FUSE BOX DISABLING HIGH VOLTAGE		HIGH VOLTAGE ULTRA-CAPACITOR
ISO 17840-3 AND OTHER PICTOGRAMS		ENGINE ACCESS LATCH TRUNK/CARGO		LOW VOLTAGE DISCONNECT		VEHICLE CHARGE PORT		VEHICLE INDUCTION CHARGING		RESPONDER CUT-LOOP
		DISCONNECT HIGH VOLTAGE VIA LOW VOLTAGE		SOLAR PANEL		HIGH VOLTAGE FUEL CELL		HIGH VOLTAGE COMPONENT		FUEL TANK WITH DIESEL FUEL
		FUEL TANK WITH GASOLINE OR ETHANOL		FUEL TANK WITH BIO-FUEL		HIGH VOLTAGE FUSE BOX		LOW VOLTAGE FUSE BOX		LOW VOLTAGE FUSE BOX DISABLING SRS



### Standard procedure to disable 12 V and High Voltage (HV) power

To disable external power to the vehicle complete step 1. To disable 12 V power from the Vehicle Systems and to disable HV Battery power external from the HV Battery complete steps 2 AND 3. Step 4 should be done if possible safely and only disables HV Battery power external of the HV Battery. Step 5 allows the charge on HV capacitors to be discharged.

The following steps must be completed in numeric order:

1. Unplug the EVSE Recharge Coupler from the Vehicle Charge Receptacle, this will stop the AC power transfer to the vehicle. Press the Recharge Coupler button and pull to remove.



Press the EVSE Recharge Coupler button and pull to remove.

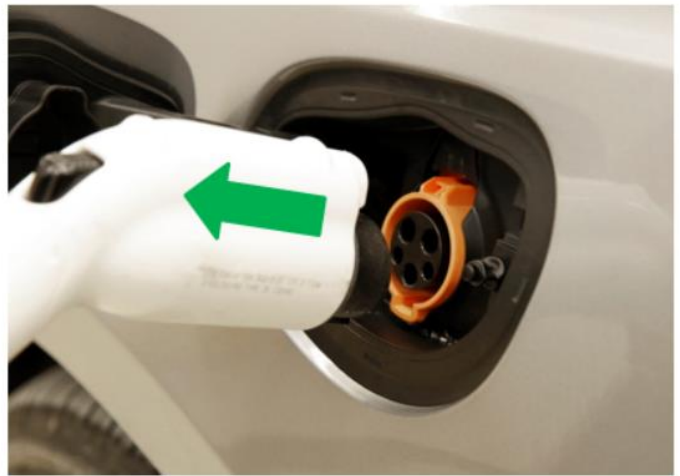

This will remove EVSE AC power from the vehicle.

*This removes externally supplied high voltage power from the vehicle.*

2. Turn off Ignition switch by pressing stop button, this will start the process of disabling 12 Volt and HV power. Remove the key fob and relocate it at least 20 feet away from the car.



Press stop button to turn off.



*This starts the normal shut-down of low and high voltage power.*

3. Physically cut the 12 V power from the vehicle, this will disable 12 V and HV power external of the HV battery. Under the hood, on the driver side rear, remove the PDC (“fuse box”) cover. Cut and remove a segment of the 12 V positive supply cable attached near the front inner corner terminal of the PDC (“fuse box”). Protect the cut ends of the positive cable from arcing against metal parts as the cable is live.

THIS STEP WILL DISABLE BOTH HIGH VOLTAGE POWER AND RESTRAINT SYSTEMS

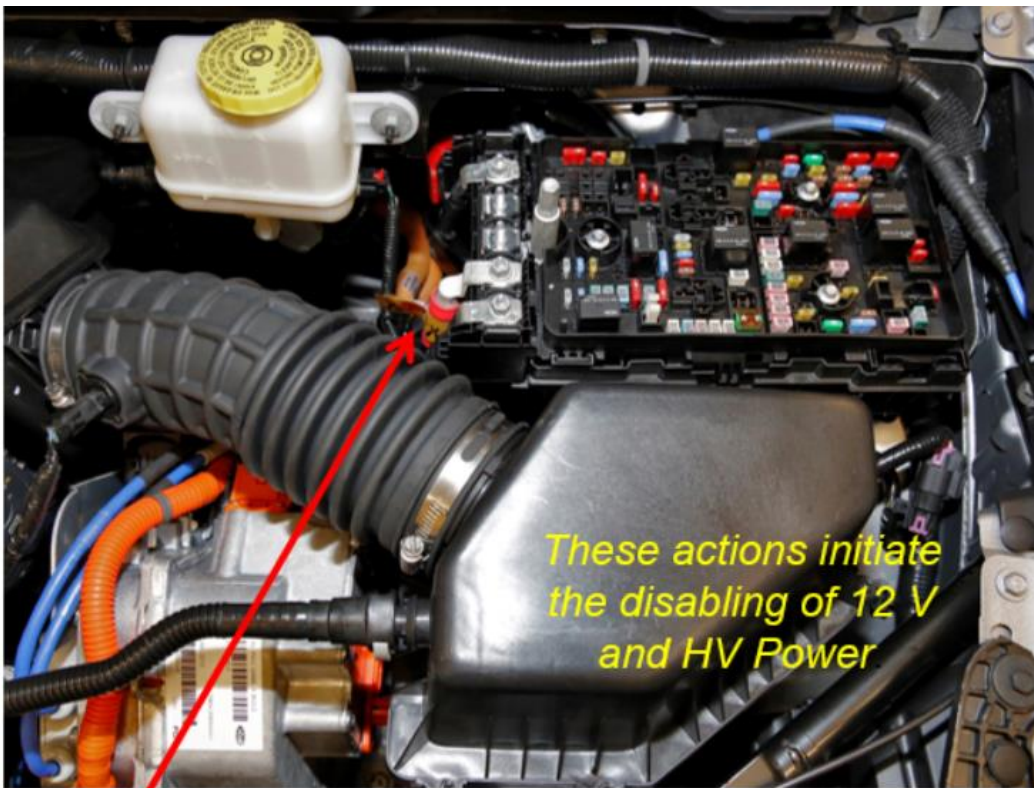

First Responders Label as seen in vehicle

WARNING: Performance of the following step (4) creates an opening in the case of the high voltage battery. Water, such as from extinguishing, gaining entry to the battery may result in hazardous emissions and battery pack fire. Proceed only if appropriate.



4. (Alternatively, if not able to do step 3 to disable high voltage) or in addition to, if possible to perform safely- Remove the Service Disconnect. The Service Disconnect cover is between the 1<sup>st</sup> and 2<sup>nd</sup> row seats.

WARNING: This will disable HV only, it does not effect low voltage and low voltage systems including restraint systems



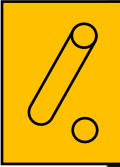

**1**  
First: Uncover the Service Disconnect access cover.



**2**  
Second: Unbolt the cover panel over the Service Disconnect.



**3**  
Third: Remove the Service Disconnect.



**4**  
Fourth: Reinstall the cover over the empty socket and replace the carpet.

5. After completing the power-down steps above, wait 5 minutes before addressing a damaged vehicle.

This will allow the HV capacitors to discharge under most circumstances. However, under some circumstances the HV Battery System HV Contactors may not open. Consequently, HV may not be contained to within the HV Battery System.

Personal Protective Equipment (HV qualified Gloves, Boots and Coat) provides protection against Live HV.

RECOMMENDED: Personal Protective Equipment must be used by First Responders when addressing a damaged Chrysler Pacifica Hybrid.

**WARNING:** Even after completion of these steps, it is possible for High Voltage to still remain accessible outside of the battery pack in the event of damage to the current-interrupting mechanism. Always treat High Voltage components as if they remain energized.

Completion of steps 1 through 3 above will normally isolate 12-volt electrical energy within the low voltage battery, and high voltage energy within the high voltage battery system. Isolation of the 12-volt energy source will disable the normal operation of restraint systems.

**Inverted vehicle emergency power-down procedure- Perform if vehicle is inverted, or hood access is blocked:**

- 1) Access the passenger compartment through the rear lift gate, gate window, or side door if possible.
- 2) Locate the 12 volt battery access on the driver's-side adjacent to the lift gate in the rear of the vehicle.
- 3) Open the battery terminal access door.
- 4) Grab the trim assembly (including upper compartment) firmly through the terminal access opening.
- 5) Pull outward to dislodge the retaining clips



- 6) Remove the trim assembly to expose the battery.
- 7) Cut away or remove all negative battery cables.
- 8) Locate the Service Disconnect floor well behind and between the front two seats and uncover.
- 9) Unbolt the inner service disconnect cover.
- 10) Remove the service disconnect.
- 11) Replace the cover to protect against water and debris.
- 12) Wait 5 minutes. *This will disable power to high and low voltage systems. However, under some circumstances the HV Battery System Contactors may not open. In such instance, either or both systems could remain energized.*

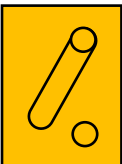

**WARNING:** No attempt should be made to drain electrical energy from the high voltage battery pack in the field. This is a task that requires the specialized training and tools available to authorized service technicians. Contact with high voltage potentials, which is possible when attempting to connect to a damaged battery system, can cause serious or fatal injury.

Electrical PPE must be worn, and contact with high voltage components avoided even after performance of these steps as a damaged vehicle system can behave in unexpected and/or undesired ways, including the continued presence of high voltage outside of the battery pack.

Impact event emergencies can require the extrication of victims from damaged vehicles. Determination of the need and timing to extricate must be made by incident command based on standard response practices and procedures.

**RECOMMENDED:** If safe to do so, remove victims from an electrified vehicle, as risk of injury from HV battery degradation can increase over time.

Potential HV electrical power system-related hazards to victims include:

- Fire, which is sustained by heat from a damaged battery or shorted wiring
- Exposure to high voltage potentials caused by damage to the isolated HV system
- Carbon monoxide and hydrogen fluoride emissions from a thermally active damaged battery, which can cause injury, blindness and death.
- Potentially explosive hydrogen emissions from a thermally active damaged battery.
- Unintended movement of the vehicle.

**RECOMMENDED:** Decisions to extricate must take into account the balance between medical condition and hazard from the state of the vehicle.

Damage to fuel systems, hot coolant lines, all high voltage electrical components and cables, the batteries, and potentially active restraint systems must be avoided at all times. See the following pages for location information. (The “Do not cut” illustrations)

Engine Compartment Access:

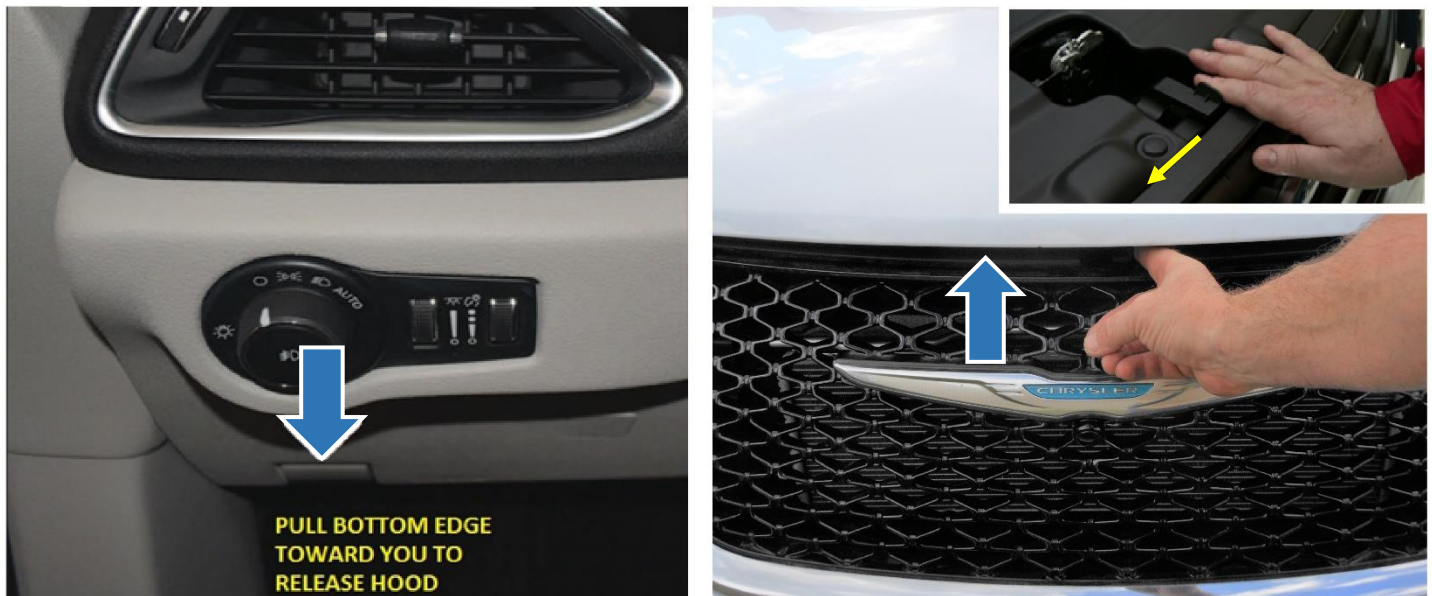

The hood release on the Chrysler Pacifica Hybrid is located to the left of the steering wheel at the base of the lower dash panel. Placing fingers upward behind the edge at the flush inset lever handle, pull outward toward you. The hood will raise slightly and catch on the safety latch. Reach under the hood to the right of center and feel for the release lever. Push lever toward the passenger side and the latch will release.

Recommended Cut Points for Extrication:

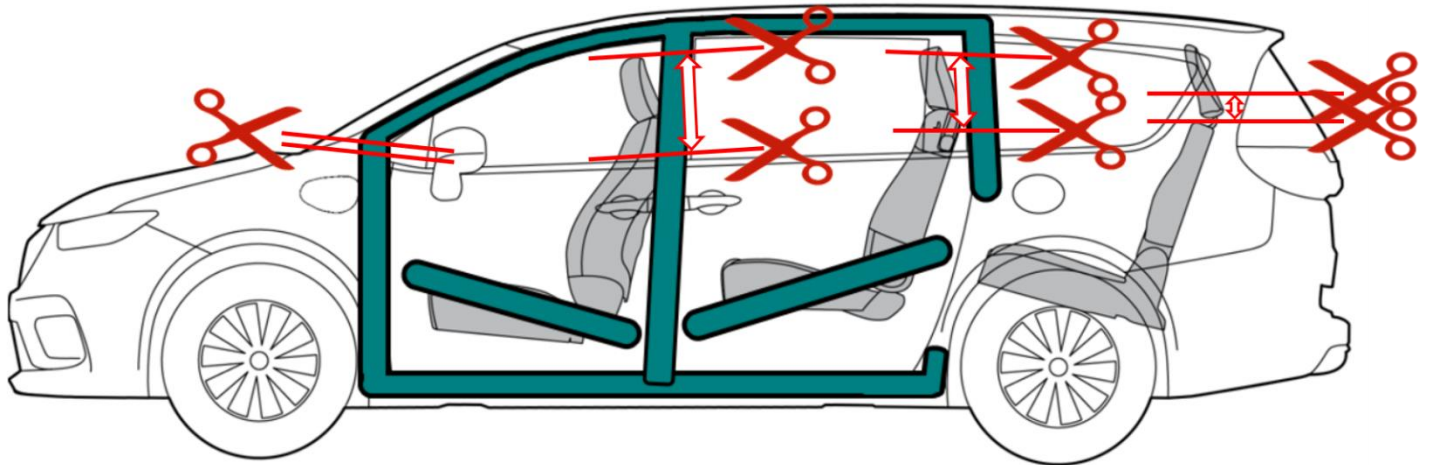

The areas illustrated between the scissor symbols are recommended cut zones on the vehicle. Determination of actual lift and cut points must be made by incident command based on the unique situational factors such as possible relocation of the hazards illustrated on the following pages as a result of impact events. These are only recommendations.

**CAUTION:** Review the “DO NOT CUT” illustrations that follow to be aware of the original placement of components that may pose electrical, thermal, kinetic or other hazards during extrication operations.

DO NOT CUT into any high voltage cables or components. Avoid cutting primary low voltage electrical components as illustrated below.

Manual Battery Service Disconnect

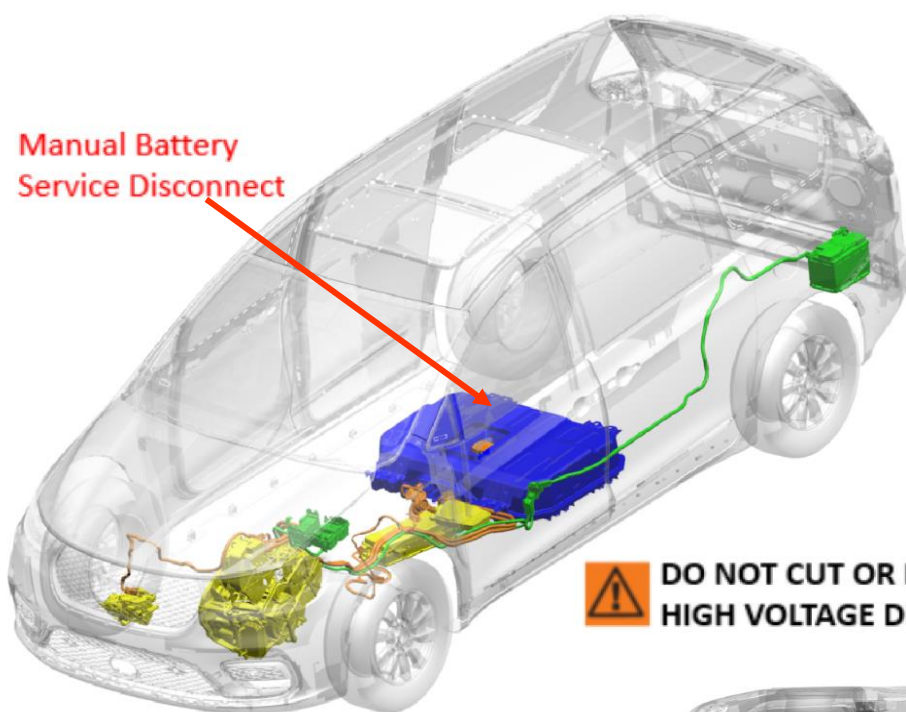

DO NOT CUT OR PIERCE HIGH VOLTAGE DEVICES

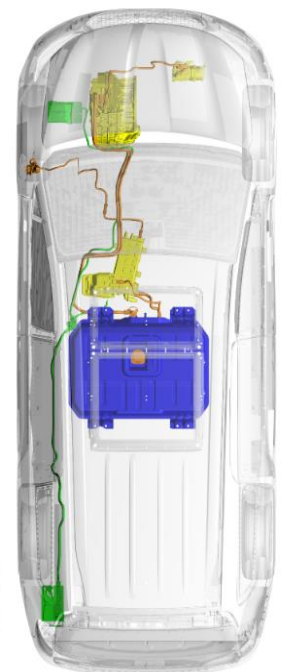

**High Power Electrical Systems:**

- High Voltage Cables
- High Voltage Components
- High Voltage Battery
- Low Voltage (12V) Battery and Cables

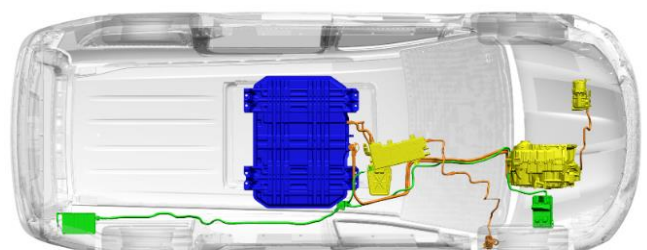

DO NOT CUT into any pressurized or combustible fluid component illustrated below.

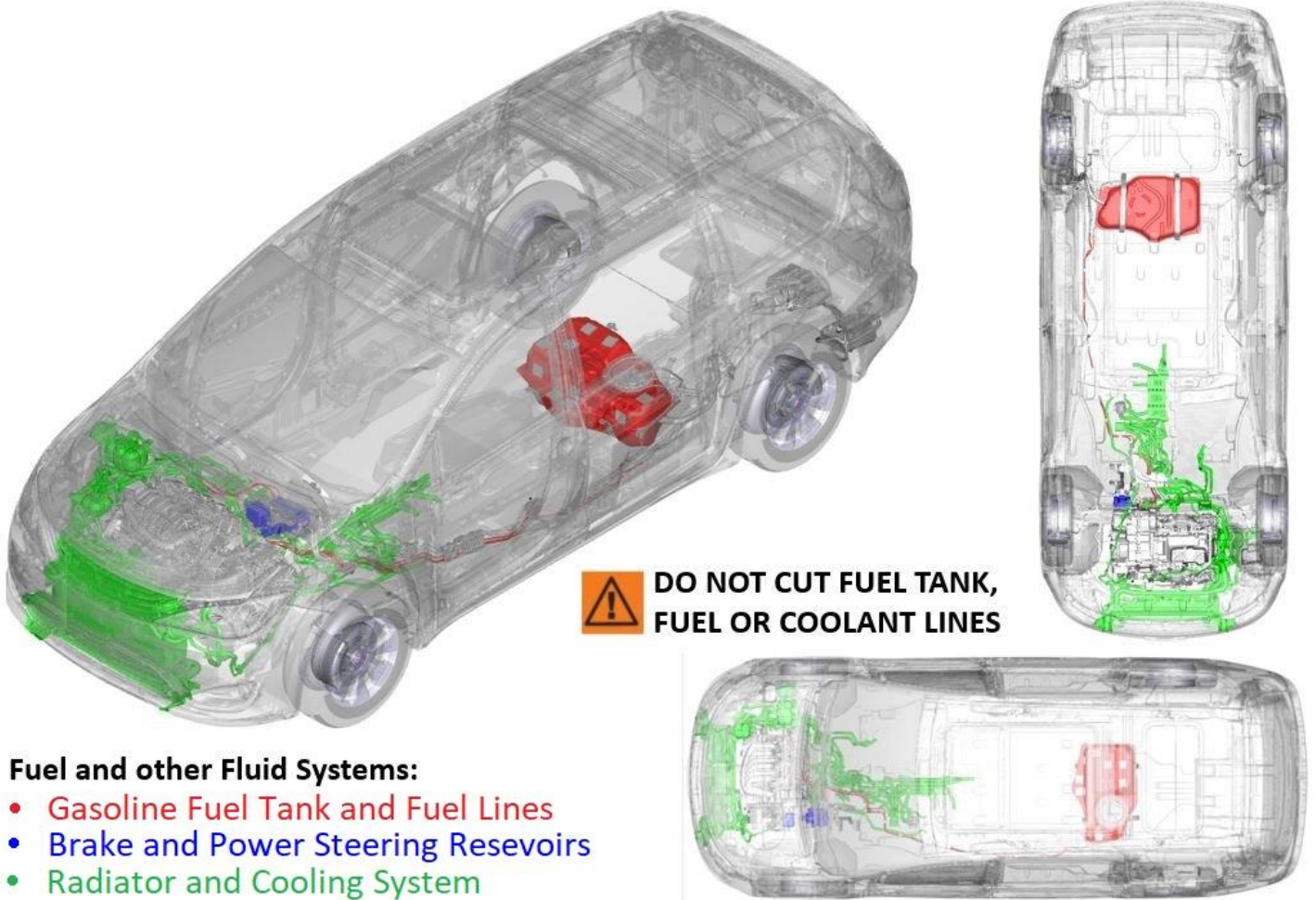

DO NOT CUT into occupant restraint components. (Fabric belts only may be cut with a knife)

**Restraint Systems:**

- Front seat belts with pretensioning devices (horizontal cylinder below the belt spool)
- Driver and front passenger air bags, seat-mounted side bolsters and leg bolsters
- Side curtain air Bags
- Impact sensors

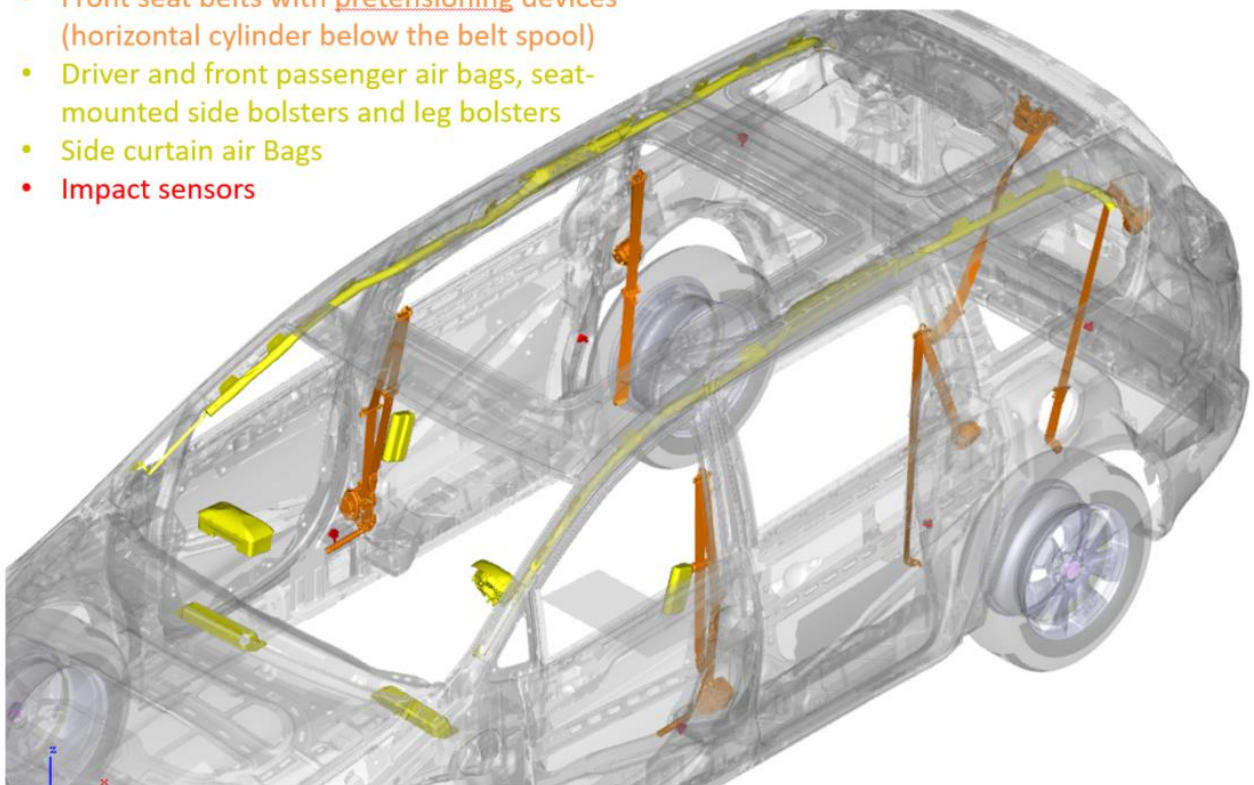



Be advised that this vehicle includes select use of high-strength structural materials which may slow cutting and extrication efforts unless addressed with appropriate tools for such materials.

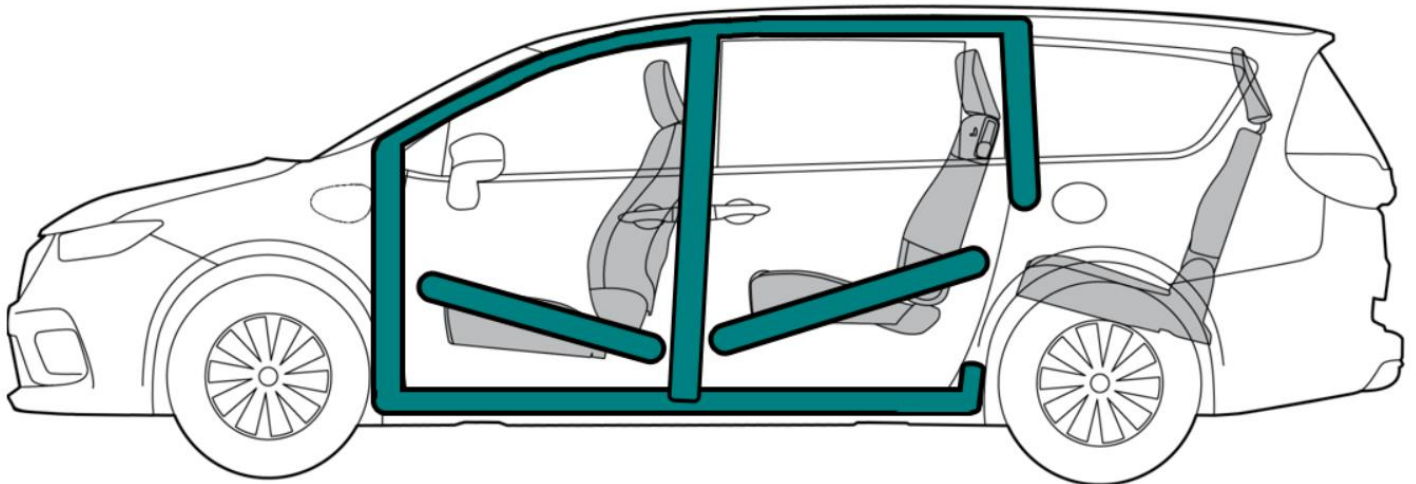

High strength steel components are illustrated in blue-green.

LAMINATED GLASS is utilized in the windshield and front door.

TEMPERED GLASS is utilized in front quarter and rear quarter glass, rear door, lift gate and sunroofs.

**WARNING:** Gaseous emissions from a thermally active damaged lithium-ion battery include hydrogen, which is explosive when mixed with oxygen in the air.



**WARNING:** Gaseous emissions from a thermally active lithium-ion battery include hydrogen fluoride which when combined with moisture in the human body forms an acid that can cause burns, respiratory distress and injury, blindness and/or death.



**RECOMENDED:** Immediately open all doors and remove all glass to maximize ventilation.

Under most circumstances, a high voltage battery at zero percent useable charge, as shown on the dash, still contains significant electrochemical energy. State of charge as displayed does not indicate any lessening of electrical shock or thermal progression potential.

**WARNING:** Do not puncture, cut, apply heat to, drop, crush, or attempt to attach electrical conductors to, any high voltage battery system or component, as injury or death may result.

**WARNING:** The specialized equipment necessary to safely discharge a high voltage battery pack is not available in the field presently. **DO NOT** attempt to improvise a means of discharge, as serious injury or death may result.

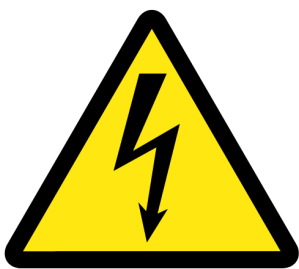

Discharging the Chrysler Pacifica Hybrid 400-volt battery below the minimum operating voltage (which shows on the dash as a zero percent charge) will do permanent damage to the battery and requires bypassing safety mechanisms as well as specialized training. Therefore, the high voltage energy should be contained exclusively to within the battery pack in an incident response situation.

To contain high voltage energy within the battery pack, under most circumstances the procedures outlined in this guide will be sufficient. However, in rare cases, the isolation device internal to the battery system may have become damaged, in which case high voltage energy may only be contained within the battery pack by means of physically disconnecting all outputs from the battery pack, and covering those connectors. This process is not recommended unless guidance from Stellantis personnel with knowledge relating to disconnecting and securing the battery pack in the specific model involved is available to responders. Contact the Stellantis battery engineering team for guidance in this regard.

**WARNING:** Even after completion of these steps, it is possible for High Voltage to still remain accessible outside of the battery pack in the event of damage to the vehicle.



**RECOMENDED:** Personal Protective Equipment must be used by First Responders when addressing a damaged Chrysler Pacifica Hybrid. Treat all high voltage components as if energized at all times.

**WARNING:** 12 volt batteries contain sulfuric acid, which can cause burns and blindness on contact, and which may be lethal if ingested.



12 VOLT BATTERIES also contain trapped electrical energy of a low voltage potential. While these do not present a shock hazard, sparks and arcs of significant energy are possible, and can ignite volatile fuel vapors at an accident scene. To reduce risk of accidental ignition,



12V battery terminals may be stripped of all connections and covered as soon as safely possible following primary response activities.

**PRESSURIZED FLUIDS:** Exist in multiple systems within the Chrysler Pacifica Hybrid. These systems include:

- Engine Cooling System and Radiator
- Power Electronics Cooling System
- Brake System
- Power Steering System
- Fuel System



**RECOMMENDED:** Avoid cutting into any tubing or components associated with these systems, as fluids may be ejected under pressure, and potentially at high temperature.

**WARNING:** Fuel is flammable, and hydraulic oil is combustible. These liquids may stick to or sink into clothing, acting as an accelerant if ignited.

The fuel system in the Chrysler Pacifica Hybrid is pressurized to protect against air pollution.

**WARNING:** The fuel system is pressurized. If the system is ruptured, gasoline vapors will escape which have the potential to detonate if exposed to a source of ignition.



**RECOMMENDED:** Prior to cutting 12-volt power, depressurize the fuel system by pressing the fuel door release button located in the driver's door map pocket and wait 15 seconds for the door to open. It may take longer to open in some situations, such as high ambient temperatures

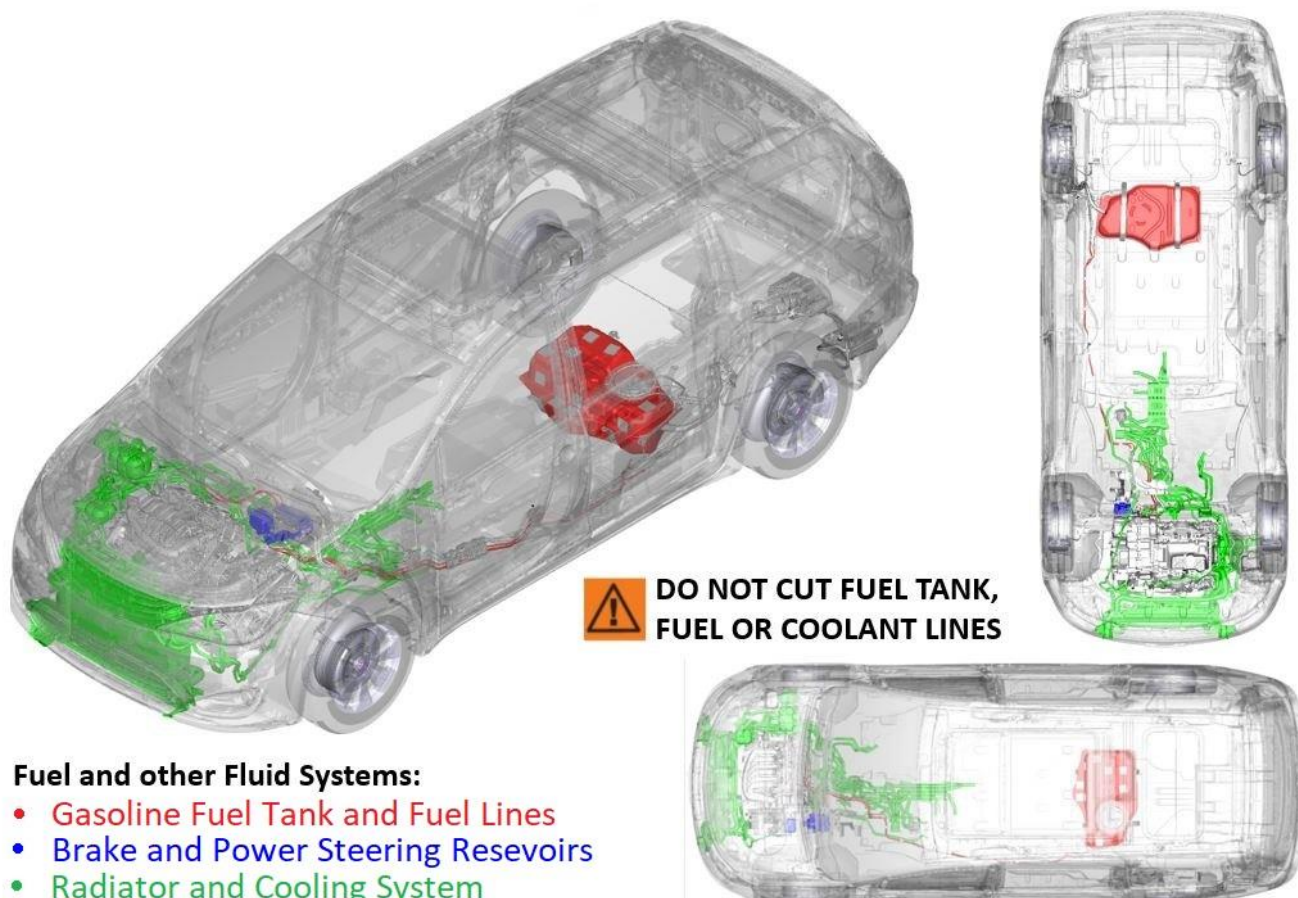

**Fuel and other Fluid Systems:**

- Gasoline Fuel Tank and Fuel Lines
- Brake and Power Steering Reservoirs
- Radiator and Cooling System

RESTRAINT SYSTEMS utilized in the Chrysler Pacifica Hybrid include two distinct sets of devices that contain “trapped energy” unless damaged or consumed. These are the seat belt retractors, and the systems that deploy various restraints upon impact.



Seat belt retractors utilize a wound spring that maintains a constant pull on the seat belt. Even when retracted, the spring still is under load. If damaged, it can shatter throwing sharp metal debris.

**WARNING: Do not cut into seat belt retractor mechanisms, as injury or blindness may result.**

Air bag and bolster actuators are, typically one-time-use, explosive devices used to rapidly inflate restraint devices on impact. Undeployed actuators can be triggered electrically by impact sensors, thermally, or sometimes by interaction with a cutting device passing into them.



Seatbelt Pretensioners employ a typically one-time-use explosive device to properly position the occupant for airbag deployment. These are a similar hazard to the airbag actuators, but can also propel metal components, or simply retract an inconveniently placed belt, with the associated risk of injury.



**WARNING: Do not cut, puncture, heat, crush, or strike air bag or bolster inflators, impact sensors, or seatbelt pretensioners, as inadvertent detonation may result in injury or death.**

**Restraint Systems:**

- Front seat belts with pretensioning devices (horizontal cylinder below the belt spool)
- Driver and front passenger air bags, seat-mounted side bolsters and leg bolsters
- Side curtain air Bags
- Impact sensors

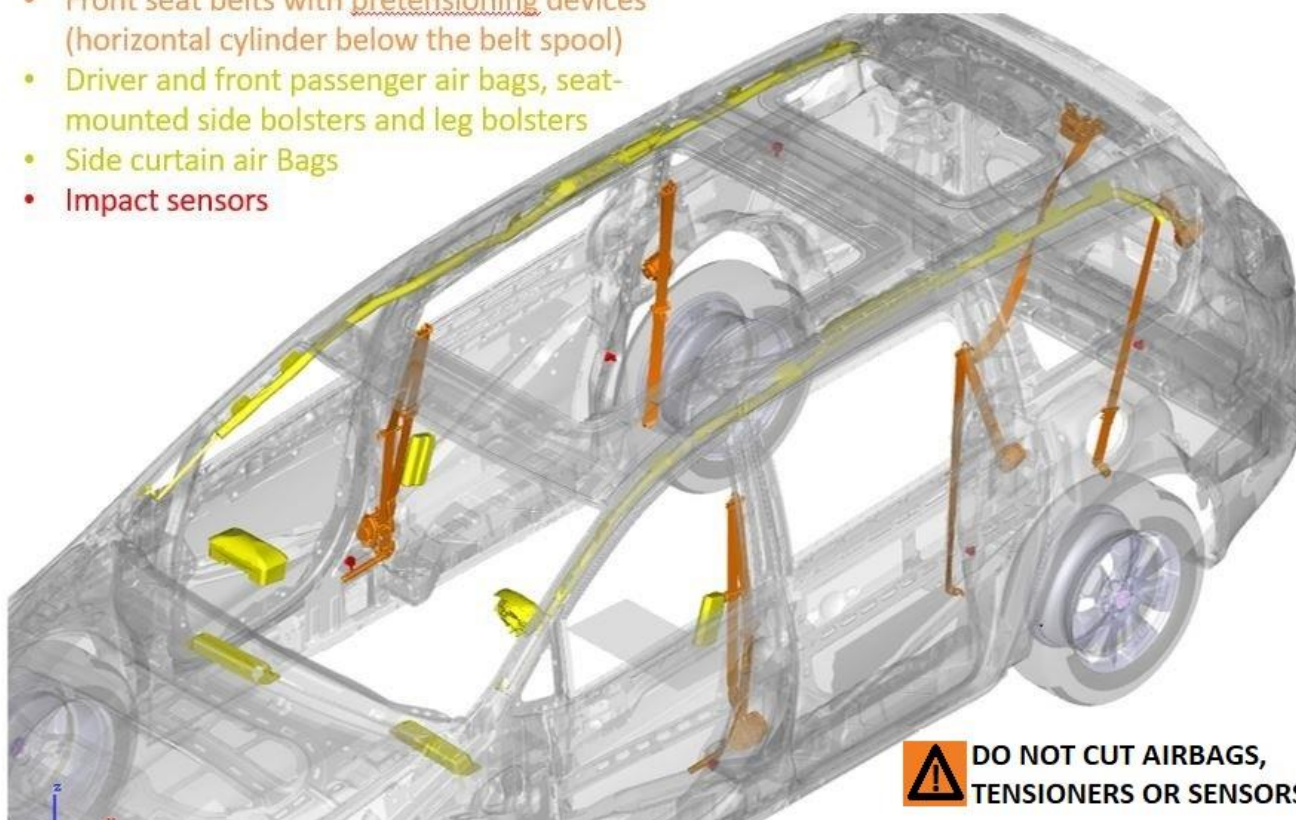

**DO NOT CUT AIRBAGS, TENSIONERS OR SENSORS**

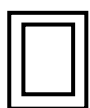

Instrument panel cross beam, steering wheel, and inner lift gate – Magnesium alloy

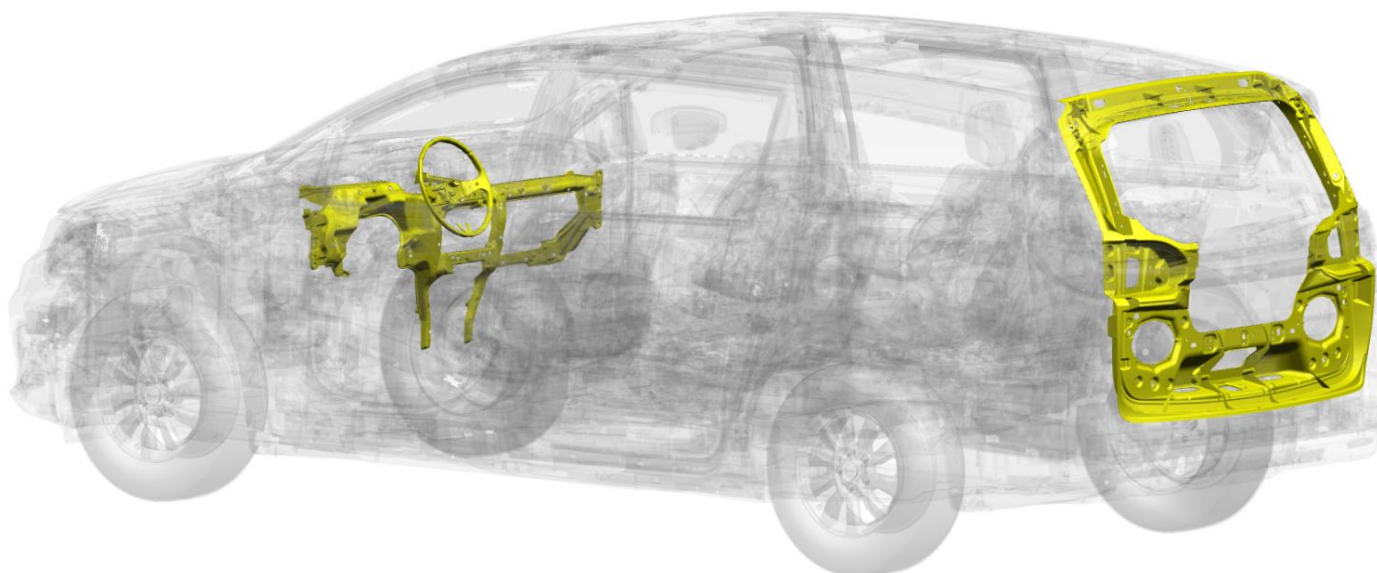

The Chrysler Pacifica Hybrid includes a high voltage lithium-ion battery system. As a result, special consideration must be given to extinguishing methods and practices.

### Fighting electrified driveline vehicle fires poses unique challenges.

- Chemical extinguishers and oxygen denial are not effective in these fires.
- Deluge with water delivered via fire hose at the maximum possible distance is the recommended practice to contain the fire and cool the reagents, minimizing risk of spread and risk of hazardous emissions. This should continue after extinguishment until the pack is cool.
- Ventilation of the passenger compartment, if occupied, is essential at the first sign of battery heating, smoke or fire.
- Batteries should be thermally assessed during initial operations and throughout rescue and remediation efforts.
- Damage, abuse, flooding or exposure to heat (such as from a vehicle fire) can initiate thermal reactions which will advance to a significant fire in lithium ion power systems.
- The Battery thermal reactions become self-sustaining at higher temperatures due to the emission of oxygen from certain constituents.
- Ongoing battery fire or heat production can facilitate the re-ignition of combustible automotive components above and adjacent to the pack.
- Lithium-ion automotive batteries can reignite due to ongoing reactions from internal heat.
- For any battery thermal event, NFPA recommends SCBA be required within fifty feet.

**WARNING:** Never cut, pierce or damage any high voltage component as serious injury or death may result. **WARNING:** Emissions from a thermally active lithium-ion battery include flammable hydrogen, and hydrogen fluoride which when combined with moisture in the human body forms an acid that can cause tissue burns, respiratory distress and injury, blindness and/or death.



**RECOMMENDED:** Application of large amounts of water should begin at the first signs of battery smoke as water may absorb some harmful toxic emissions in the smoke.

**RECOMMENDED:** Immediately open all doors and remove all glass to maximize ventilation.

**RECOMMENDED:** Rescue of persons at risk and containment of the fire with prevention of hazardous gas emissions should be the goals of fire-fighting efforts.

**RECOMMENDED:** An infrared thermometer should be used to assess the batteries thermal activity.

**WARNING:** Never cut, pierce or damage any high voltage component as serious injury or death may result.



A vehicle submerged or flooded with water can result in protective system failures.



Excessive heat and electrolysis may take place resulting in byproducts of hydrogen and oxygen. In salt water, chlorine is also a byproduct. These byproducts, trapped and concentrated by the passenger compartment, a



garage, or other containment, may be in concentrations that could be explosive or corrosive and could have adverse effects on human health. Action should be taken to assure ventilation of a partially submerged vehicle and any space in which it is contained.

For a Pacifica Hybrid that is without physical damage (such as from an accident) the risk of electrical shock when submerged or flooded is not increased.



**WARNING:** A vehicle with impact damage presents an increased electrical shock hazard risk. If HV is open to the environment you must stay away from damaged HV components.

**RECOMMENDED:** Responders must use proper Personal Protective Equipment when addressing a damaged Pacifica Hybrid vehicle.

**When removing an undamaged vehicle:**

Towing Condition	Wheels OFF The Ground	FWD MODELS	AWD MODELS
Flat Tow	NONE	NOT ALLOWED	NOT ALLOWED
Wheel Lift Or Dolly Tow	Front	ALLOWED	NOT ALLOWED
	Rear	NOT ALLOWED	NOT ALLOWED
Flatbed	ALL	BEST METHOD	BEST METHOD

Proper towing or lifting equipment is required to prevent damage to your vehicle. Use only tow bars and other equipment designed for this purpose, following equipment manufacturer’s instructions. Use of safety chains is mandatory. Attach a tow bar or other towing device to main structural members of the vehicle, not to fascia/bumper or associated brackets. State and local laws regarding vehicles under tow must be observed.

The above towing chart covers Front Wheel Drive (FWD) and All Wheel Drive (AWD) models. The Chrysler Pacifica Hybrid is an FWD.

You must be certain that the Auto Park Brake feature is disabled before towing this vehicle (if the rear wheels are on the ground), to avoid inadvertent Electric Park Brake engagement. The Auto Park Brake feature is enabled or disabled via the owners’ programmable features in the U-Connect Settings.

Vehicles with a discharged battery or total electrical failure when the EPB is engaged, will need a wheel dolly or jack to raise the rear wheels off the ground when moving the vehicle onto a flatbed.

Transporting of a Chrysler Pacifica Hybrid by flatbed truck or trailer with all four tires **OFF** the ground is the preferred method.

If flatbed equipment is not available, a Chrysler Pacifica Hybrid vehicle must be towed with the front wheels **OFF** the ground (using a towing dolly, or wheel lift equipment with the front wheels raised).

Towing this vehicle in violation of the above requirements can cause severe transmission damage. Damage from improper towing is not covered under the New Vehicle Limited Warranty.

**When removing a damaged vehicle and remediating the area after an incident:**

**FLUIDS:** The Chrysler Pacifica Hybrid battery is a “non-spillable” qualifying architecture. Battery electrolyte remains trapped in the internal elements of the electrical cells. Liquid spilled from a high voltage battery pack is primarily engine coolant.

Collect spilled fluids for disposal as follows:

- Collect spilled engine coolant and any coolant from electronic systems in the normal manner for spilled glycol/water mix.
- Collect spilled engine and hydraulic oil with absorbent material, and use detergents to recover from masonry. Collect contaminated ground for disposal in accordance with local requirements as applicable.
- Collect spilled gasoline in the same manner as oils, but employ precautions for the management of flammable and explosive vapors.





- Collect spilled 12 V battery electrolyte with an absorbent that neutralizes the highly acidic sulfuric acid electrolyte. Do not handle 12 V battery electrolyte, or materials contaminated with 12 V battery electrolyte without chemically resistant protection.



**BATTERY PACK DEBRIS:** In the event of significant damage to and fragmentation of the high voltage battery pack, all debris should be collected and disposed of. While not classified as a hazardous waste, skin contact with battery pack internal elements is to be avoided.

**POST-INCIDENT DELIVERY TO SERVICE:** If air bags have deployed, the vehicle cannot be driven again until repaired, as air bag protection will not be available to occupants in the event of a collision. After any collision, the vehicle should be taken to an authorized dealer immediately.



**VEHICLE MOVEMENT:** The rotation of the wheels at more than creep speeds can cause the generation of electrical energy in damaged vehicles. This may reach high voltage potentials. Additionally, in damaged systems with remaining propulsion ability, movement of the wheels could trigger a driveline response and result in unexpected movement of the vehicle.  
**DO NOT PUSH BY HAND.**

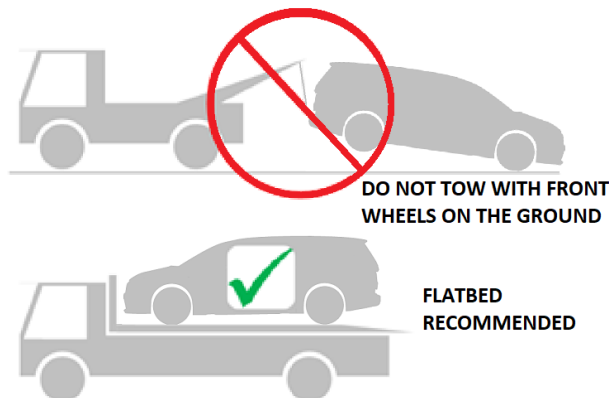

**PREPARATION FOR TOWING:** The relocation of a damaged vehicle must be by means of a trailer, flatbed or similar conveyance that will not allow rotation of the front drive wheels. For loading, ideally drag the drive wheels in a locked position, or if drive wheels must rotate, move the car at speeds of no more than 12 feet per minute.



**WARNING:** During preparation, transport and storage, isolation and observation of the vehicle, particularly the high voltage battery pack, is necessary to watch for, and react to, any signs of delayed ignition or re-ignition of the battery pack.



**RECOMMENDED:** An infrared thermometer should be used to assess the batteries thermal activity.

Damaged vehicle towing instructions:

- Secure the vehicle to the means by which it will be loaded onto the trailer or flatbed.
- Set the transmission to PARK. Set the PARKING BRAKE. This will lock the wheels in place and require dragging the vehicle to load.
- Drag the vehicle onto the trailer or flatbed.
- Secure the vehicle to the trailer or flatbed for transit.
- WARNING:** If the transmission were left in (N) neutral, the vehicle will roll freely when not secured. Do not unsecure without a means of preventing unintended motion.

If circumstances require that the damaged vehicle be allowed to roll, such must be kept to a minimum and at creep speeds only. If 12-volt power is disabled, and the vehicle is in PARK, it will be necessary to follow these steps:

1. Using a jack or equivalent, raise the vehicle only high enough to insert wheel dollies under the front wheels.
2. Lower the vehicle so that front wheels are centered on the dollies.

**POST-INCIDENT HANDLING:**

Following initial response, certain actions and precautions are necessary. If air bags have deployed, the vehicle cannot be driven again until repaired, as air bag protection will not be available to occupants in the event of a collision. After any collision, the vehicle should be taken to an authorized dealer immediately.

While the Chrysler Pacifica Hybrid HV battery is designed for safety, industry-wide experience has demonstrated that the unlikely possibility of delayed ignition or re-ignition of a damaged battery must be considered in post-incident handling. Any battery exposed to accident forces sufficient to deploy air bags or to a vehicle fire requires special precautions until verified as undamaged.

- The vehicle or battery pack must not be stored inside a structure, occupied or otherwise.
- Adequate ventilation must be present at the storage location to prevent buildup of any outgassing.
- Batteries to be recycled must be shipped in accordance with regulations governing the transport of damaged lithium-ion batteries (and never by air).
- Thermal monitoring of any damaged, flooded or burned battery should be performed during storage.
- The manual battery Service Disconnect must not be reinstalled by other than an authorized technician.
- The Service Disconnect socket must be covered/sealed to prevent water or debris entering the battery.
- The battery pack in this vehicle uses non-spillable lithium-ion cells, and it is unlikely that electrolyte, which is clear, will escape from the pack in the event of damage. Liquid emissions from damaged packs are typically colored battery coolant, which should be addressed in the same manner as spilled engine coolant.
- Do not apply chemical neutralizers used for other battery types to Lithium-ion battery components, or take any other action which could result in battery cell contents being aerosolized.

Do not ingest, inhale, or make bare skin contact with any internal material from the battery cells. In the event of accidental contact of this nature, wash exposed skin thoroughly with soap and water for at least 5 minutes and seek medical attention. In the event of ingestion, seek emergency medical care immediately.

Stellantis / FCA US Customer Center: (877) 426-5337

Stellantis / FCA Canada Customer Center: (800) 465-2001 (English) (800) 387-9983 (French)

Stellantis / FCA Mexico Customer Center: +(52) 55 50817568

Stellantis / FCA within Mexico City only: (800) 505-1300

Stellantis / FCA Caribbean Customer Center: (877) 426-5337

Service Manuals are available in the US and Canada from Tech Authority: (800) 890-4038

The Chrysler Pacifica Hybrid is designed and built with a focus on protecting both our customers and the environment. Nonetheless, when vehicles are damaged or catch fire, a number of substances are released which may be harmful to life or the environment. Obtaining material safety information in accordance with your organization’s practices may be useful with regard to:

Gasoline	Lead	Hydrogen	Methyl Carbonate
Ethanol	Sulfuric Acid	Hydrogen Fluoride	Ethyl Carbonate
Ethylene Glycol	Hydrogen Sulfate	Hydrofluoric Acid	
Hydraulic oils	Vinyl Chloride	Benzene	
Motor oil	Chlorine gas	Pentafluoral Phosphate	

**RECOMMENDED:** The use of SCBA within 50 feet of any vehicle event involving a thermally active lithium-ion battery pack, including following initial extinguishing activity, is recommended by NFPA as well as by Stellantis.

	GASOLINE-ELECTRIC VEHICLE		IMPORTANT INFORMATION		ELECTRICAL SHOCK HAZARD
	RISK OF FIRE		RISK OF EXPLOSION		HARMFUL OR LETHAL TO HUMAN HEALTH
	CORROSIVE SUBSTANCE		RISK OF INJURY		LITHIUM-ION BATTERY—HANDLE APPROPRIATELY
	DO NOT PUSH VEHICLE		RELOCATE KEY FOB AWAY FROM VEHICLE		RISK OF THERMAL ACTIVITY FROM BATTERY SYSTEM
	FLATBED/TRAILER TOW RECOMMENDED		DO NOT TOW WITH FRONT WHEELS ON GROUND		

3-Dimensional illustrations utilized in this guide are constructed as if the bulk of the vehicle is semi-transparent, with the components of interest shown in solid color.

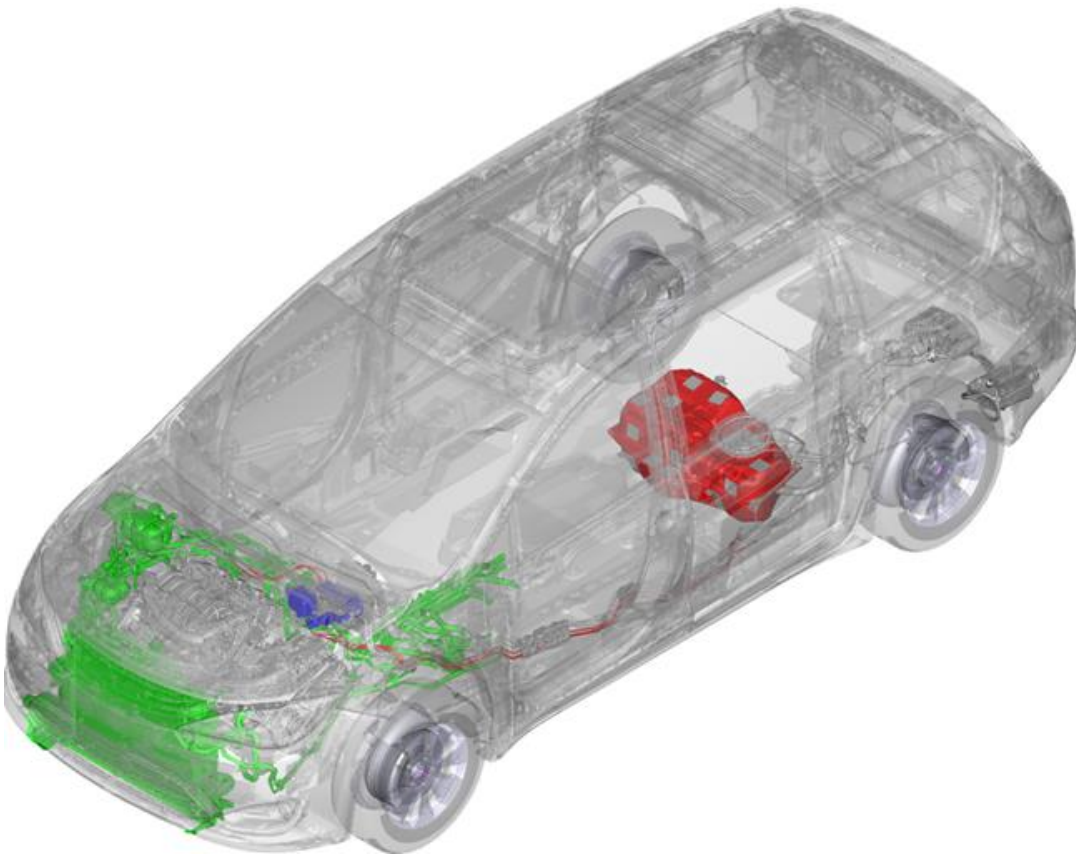

These illustrations are intended to convey the location of the components of interest within the 3-dimensional form of the vehicle to aid responders in estimating where those components lie within the vehicle with which they are presented – recognizing that it may be in a somewhat different form.