



## 2024 JEEP WRANGLER 4Xe HYBRID

# EMERGENCY RESPONSE GUIDE



Gasoline-Electric Hybrid Vehicle

Revision 2023-05-06-01

This brochure is a publication of FCA US LLC. All product illustrations and specifications are based upon current information at the time of publication approval. FCA US LLC reserves the right to make changes from time to time, without notice or obligation, in prices, specifications, colors and materials, and to change or discontinue models, which are considered necessary to the purpose of product improvement or for reason of design and/or marketing.

# CONTENTS

|   |         |
|---|---------|
| 1. Identification / recognition   | Page 3  |
| 2. Immobilization / stabilization / lifting                               | Page 5  |
| 3. Disable direct hazards / safety regulations                            | Page 7  |
| 4. Access to the occupants  | Page 12 |
| 5. Stored energy / liquids / gases / solids                               | Page 16 |
| 6. In case of fire  | Page 20 |
| 7. In case of submersion  | Page 21 |
| 8. Towing / transportation / storage (2 <sup>nd</sup> Responder Guidance) | Page 22 |
| 9. Important additional information                                       | Page 26 |
| 10. Explanation of pictograms used  | Page 28 |

The Wrangler 4Xe Hybrid can be identified by the following external indications:



A charge port, which is located at the driver-side cowl side panel.



Unique badging on driver-side rear.

The Wrangler 4Xe Hybrid can be identified by the following internal indications:



Drive mode selector to the left of the steering wheel.



Charge status indicator on the dash panel.

Jeep Wrangler vehicles equipped with these features are hybrid-electric vehicles and utilize a high voltage lithium-ion power source in addition to liquid fossil fuel for propulsion energy. All practices and precautions for working with hybrid-electric vehicles should be followed when responding to an incident involving one of these vehicles.





The Jeep 4Xe Wrangler Hybrid employs electronic shift controls. With 12-volt power active (ignition set to “RUN” or “ACC”), the transmission can be shifted between any mode including PARK and NEUTRAL, and the parking brake can be engaged or disengaged.

**NOTE:** For rescue and firefighting activities, if safe to do so, put the vehicle into PARK and engage the brake.

### Shifting in and out of PARK



- This vehicle uses a shift lever for the automatic transmission. To shift the vehicle to park, press the lock button on the shifter knob, and move to the full forward position.
- To place the vehicle in Neutral, press the brake, then press the lock button on the shifter knob and move shift lever rearward from Park two positions until the “N” LED is illuminated.

### Actuating the Parking Brake



- The parking brake lever is rearward and to the left of the shift lever. The LED illuminates when the brake is set.
- To apply the brake, pull the lever up as firmly as possible.
- When the parking brake is applied, with the ignition switch ON, the “Brake Warning Light” in the instrument cluster will illuminate.
- To release the parking brake, pull the lever up slightly, push the center button, then lower completely.

**WARNING:** The transfer case NEUTRAL position disengages both the front and rear wheels even if the transmission is in PARK. Failure to account for the transfer case mode selected may lead to unanticipated motion or lack of motion, and subsequent injury or death.



**WARNING:** In rare instances, rotation of the drive wheels may result in the generation of high voltage electrical energy external to the high voltage battery isolation device, and may also trigger a propulsion system response. Place in PARK to prevent rotation if able. DO NOT PUSH.

In addition to the use of wheel chocks, if deemed appropriate by incident command, the Wrangler 4Xe Hybrid may be lifted off its wheels to further stabilize or gain access. This lifting should be accomplished by supporting only at the lift points along the frame rail indicated by arrows shown below:

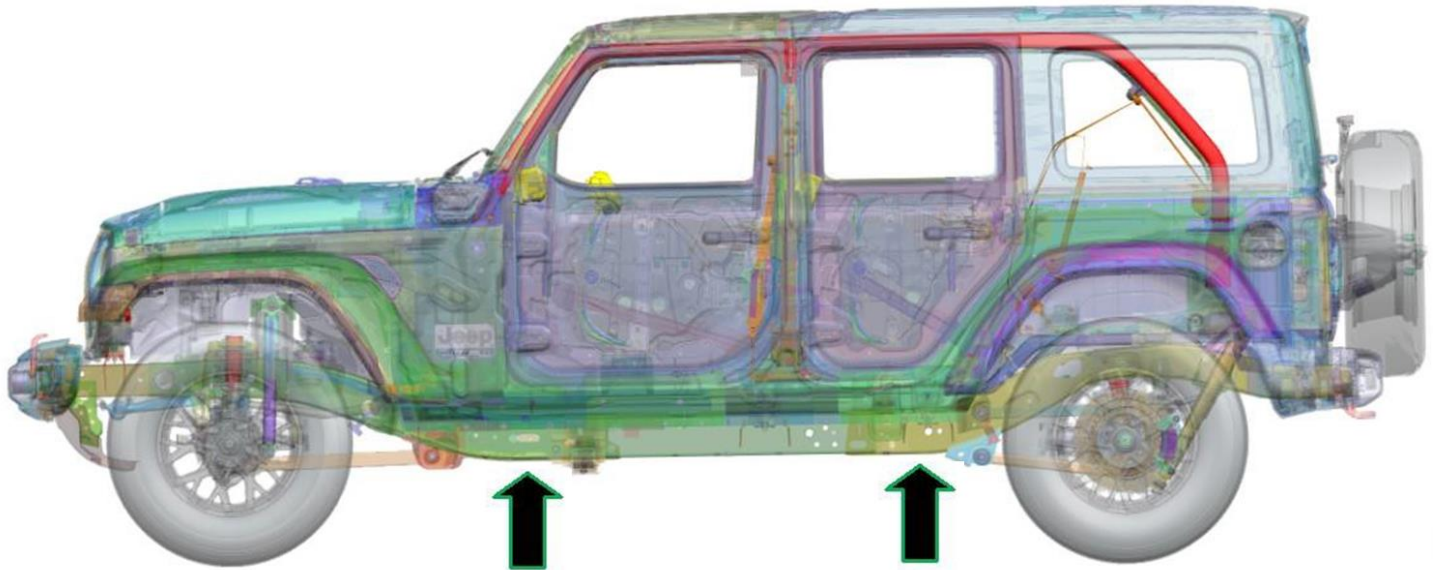

**NOTE:** Determination of actual lift points must be made by incident command based on the unique situational factors such as possible relocation of the hazards illustrated on the ensuing pages as a result of impact events. These are only recommendations.

Jeep Wrangler 4x4 4Xe Plug-in Hybrid – RESCUE SHEET

Jeep

WRANGLER 4x4 4Xe Plug-in Hybrid

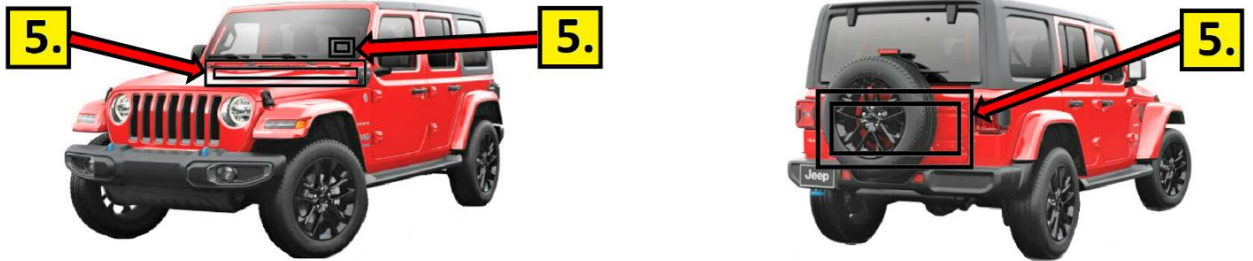

Note: The Rescue Sheet depicts a LHD vehicle (as allowed under the ISO 17840-1). All components (other than steering wheel and passenger airbag) are located in the same position in the Aust/NZ RHD model.

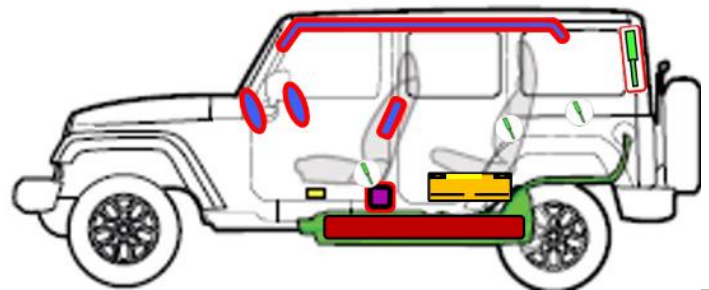
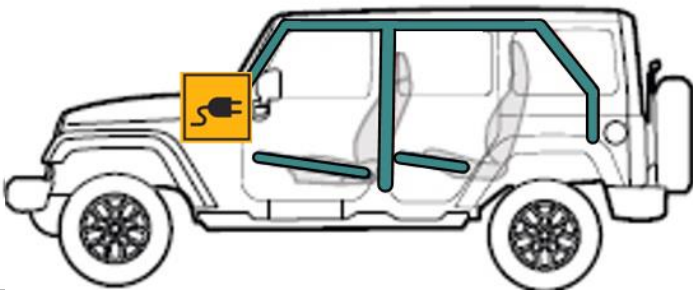
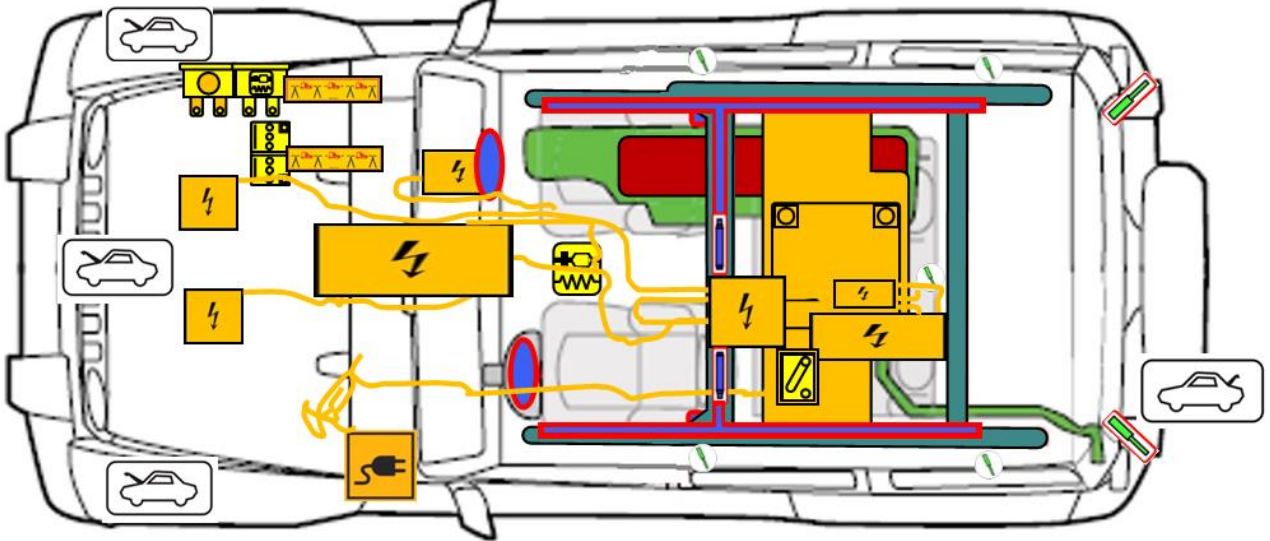

|                                  |  |   |  |  |  |                                 |  |   |                                    |
|----------------------------------|--|---|--|--|--|---------------------------------|--|---|------------------------------------|
| ISO 17840-1 PICTOGRAMS           |  | OCCUPANT/CURTAIN/BOLSTER AIR BAG AND INFLATOR |  | AIR BAG INFLATOR                             |  | SEATBELT PRETENSIONER           |  | AUTOMATIC ROLL-OVER PROTECTIO               |                                    |
|                                  |  | PEDESTRIAN PROTECTION DEVICE                  |  | GAS STRUT, PRE-LOADED SPRING, BELT RETRACTOR |  | RESTRAINT SYSTEM CONTROL MODULE |  | HIGH STRENGTH ZONE                          | ZONE REQUIRING SPECIAL ATTENTION   |
|                                  |  | LOW VOLTAGE BATTERY                           |  | LOW VOLTAGE ULTRA-CAPACITOR                  |  | FUEL TANK                       |  | COMPRESSED GAS TANK                         | SAFETY VALVE COMPRESSED GAS        |
|                                  |  | HIGH VOLTAGE BATTERY PACK                     |  | HIGH VOLTAGE CABLE                           |  | HIGH VOLTAGE DISCONNECT         |  | LOW VOLTAGE FUSE BOX DISABLING HIGH VOLTAGE | HIGH VOLTAGE ULTRA-CAPACITOR       |
| ISO 17840-3 AND OTHER PICTOGRAMS |  | ENGINE ACCESS LATCH TRUNK/CARGO               |  | LOW VOLTAGE DISCONNECT                       |  | VEHICLE CHARGE PORT             |  | VEHICLE INDUCTION CHARGING                  | RESPONDER CUT-LOOP                 |
|                                  |  | DISCONNECT HIGH VOLTAGE VIA LOW VOLTAGE       |  | SOLAR PANEL                                  |  | HIGH VOLTAGE FUEL CELL          |  | HIGH VOLTAGE COMPONENT                      | FUEL TANK WITH DIESEL FUEL         |
|                                  |  | FUEL TANK WITH GASOLINE OR ETHANOL            |  | FUEL TANK WITH BIO-FUEL                      |  | HIGH VOLTAGE FUSE BOX           |  | LOW VOLTAGE FUSE BOX                        | LOW VOLTAGE FUSE BOX DISABLING SRS |
|                                  |  | FUEL TANK WITH GASOLINE OR ETHANOL            |  | FUEL TANK WITH BIO-FUEL                      |  | HIGH VOLTAGE FUSE BOX           |  | LOW VOLTAGE FUSE BOX                        | LOW VOLTAGE FUSE BOX DISABLING SRS |



### Standard procedure to disable 12 V and High Voltage (HV) power

To disable external power to the vehicle complete step 1. To disable 12 V power from the Vehicle Systems and to disable HV Battery power external from the HV Battery complete steps 2 AND 3. Step 4 should be done if possible safely and only disables HV Battery power outside of the HV Battery. Step 5 allows the charge on HV capacitors to be discharged.

The following steps must be completed in numeric order:

1. Unplug the EVSE Recharge Coupler from the Vehicle Charge Receptacle, this will stop the AC power transfer to the vehicle. Press the Recharge Coupler button and pull to remove.



Press the EVSE Recharge Coupler button and pull to remove.



Remove EVSE AC power from the vehicle.

*This removes externally supplied high voltage power from the vehicle.*

2. Turn off Ignition switch by pressing stop button, this will start the process of disabling 12 V and HV power. Remove the key fob and relocate it at least 20 feet away from the car.

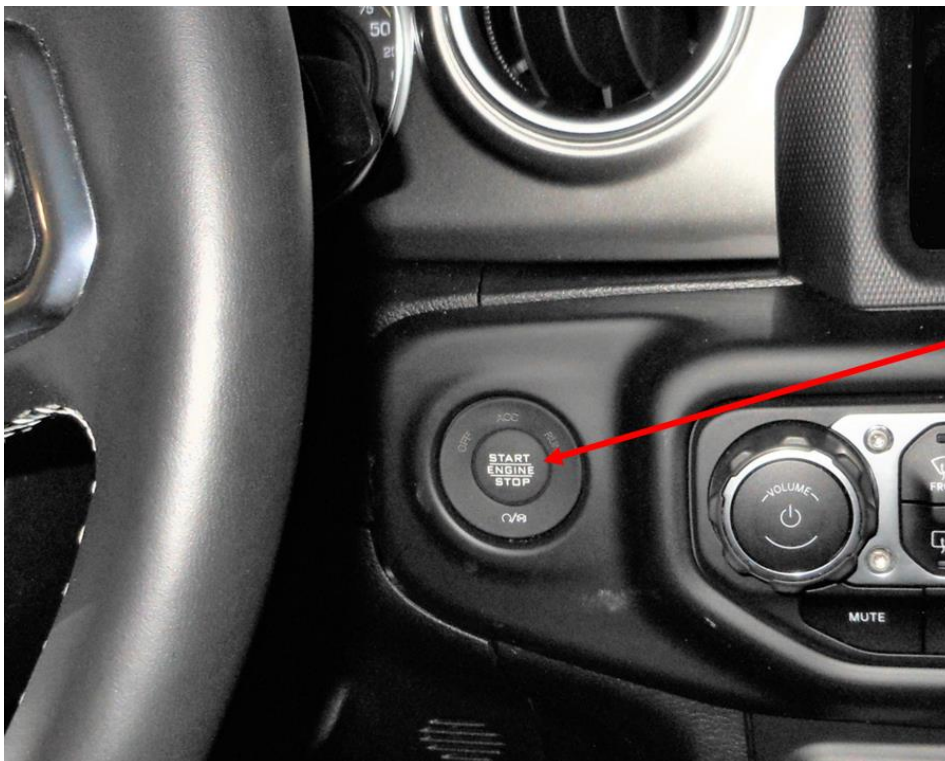

Press stop button to turn off.

*This starts the normal shut-down of low and high voltage power.*



3. Physically cut the 12 V power from the vehicle, this will disable 12 V and HV power external of the HV battery. Remove a segment of the negative supply cable at the 12 V battery by cutting on each side of the responder label located at the negative battery post. Remove a segment of the 12 V positive supply cable attached to the corner terminal of the PDC (“fuse box”) in the front in the same manner. Protect the cut ends of the positive cable from arcing against metal parts as the cable is live.

THIS STEP WILL DISABLE BOTH HIGH VOLTAGE POWER AND RESTRAINT SYSTEMS



First Responders Label  
as seen in vehicle



4. (Alternatively if not able to do step 3 to disable high voltage) Remove the Test Points access cover.

WARNING: This will disable HV only, it does not effect low voltage systems including restraints systems.

WARNING: Performance of step (4) creates an opening in the case of the high voltage battery. Water, such as from extinguishing activities, gaining entry to the battery may result in hazardous emissions and battery pack fire. Proceed only if appropriate.



Step 4 continued:

**First**, expose the HV battery Test Points Access Cover by folding driver's side second row seat cushion forward by pulling from the rear of the cushion.



**Second**, lift away the HV battery Test Points Access Cover by removing the eight Torx T-25 fasteners; this opens the HV battery power circuit. **This only disables High Voltage.**



View with access cover removed.

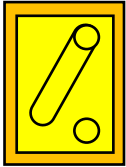

5. After completing the power-down steps above, wait 5 minutes before addressing a damaged vehicle.

This will allow the HV capacitors to discharge under most circumstances. However, under some circumstances the HV Battery System HV Contactors may not open. Consequently, HV may not be contained to within the HV Battery System.

Personal Protective Equipment (HV qualified Gloves, Boots and Coat) provides protection against Live HV.

RECOMMENDED: Personal Protective Equipment must be used by First Responders when addressing a damaged Jeep Wrangler 4Xe Hybrid.



**WARNING:** Even after completion of these steps, it is possible for High Voltage to still remain accessible outside of the battery pack in the event of damage to the current-interrupting mechanism. Always treat High Voltage components as if they remain energized.

Completion of steps 1 through 3 above will normally isolate 12-volt electrical energy within the low voltage battery, and high voltage energy within the high voltage battery system. Isolation of the 12-volt energy source will disable the normal operation of restraint systems.



WARNING: No attempt should be made to drain electrical energy from the high voltage battery pack in the field. This is a task that requires the specialized training and tools available to authorized service technicians. Contact with high voltage potentials, which is possible when attempting to connect to a damaged battery system, can cause serious or fatal injury.

Electrical PPE must be worn, and contact with high voltage components avoided even after performance of these steps as a damaged vehicle system can behave in unexpected and/or undesired ways, including the continued presence of high voltage outside of the battery pack.



Impact event emergencies can require the extrication of victims from damaged vehicles. Determination of the need and timing to extricate must be made by incident command based on standard response practices and procedures.

**RECOMMENDED:** If safe to do so, remove victims from an electrified vehicle, as risk of injury from HV battery degradation can increase over time.

Potential HV electrical power system-related hazards to victims include:

- Fire, which is sustained by heat from a damaged battery or shorted wiring
- Exposure to high voltage potentials caused by damage to the isolated HV system
- Carbon monoxide and hydrogen fluoride emissions from a thermally active damaged battery, which can cause injury, blindness and death.
- Potentially explosive hydrogen emissions from a thermally active damaged battery.
- Unintended movement of the vehicle.

**RECOMMENDED:** Decisions to extricate must take into account the balance between medical condition and hazard from the state of the vehicle.

Damage to fuel systems, hot coolant lines, all high voltage electrical components and cables, the batteries, and potentially active restraint systems must be avoided at all times. See the following pages for location information. (The “Do not cut” illustrations)

Engine Compartment Access:



The hood catches on the Wrangler 4Xe Hybrid are located on the left and right side at the front of the hood. Placing fingers at the top of the catch handle, behind the edge, pull outward and then downward to release the catch. Then pull the catch receiver hook outward. Repeat on the opposite side. The hood will raise slightly and catch on the safety latch. Reach under the hood to the left of center and feel for the release. Push safety latch to the driver side and the latch will release.

## Recommended Cut Points for Extrication:

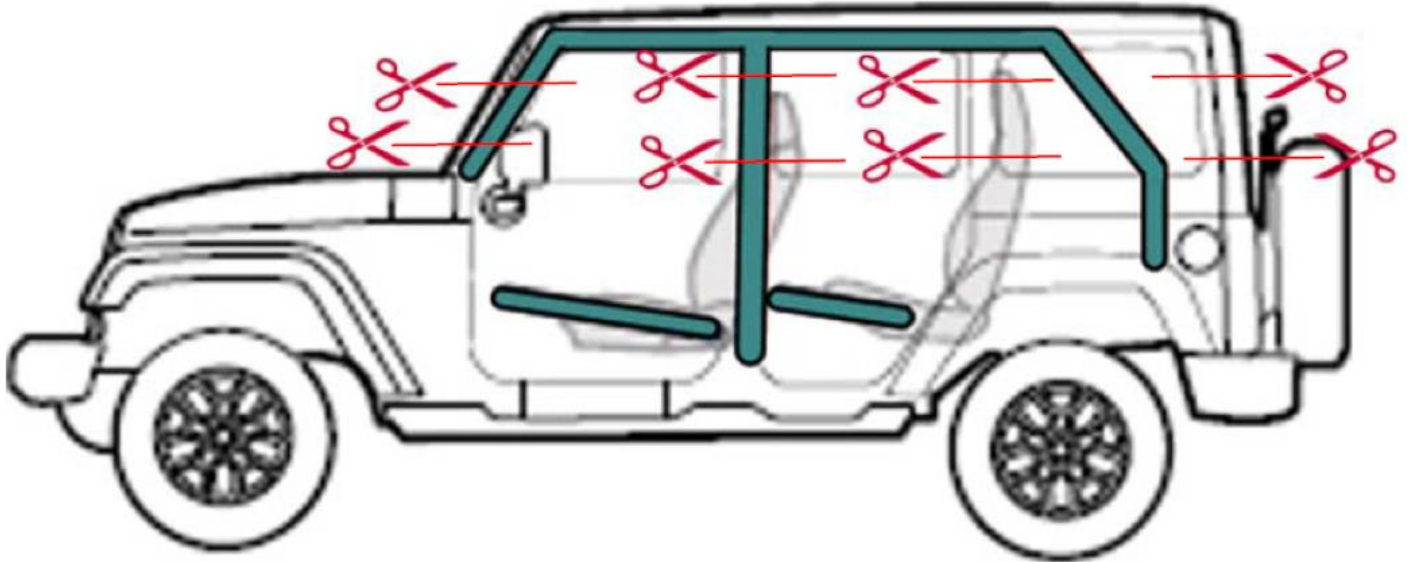

The areas illustrated between the scissor symbols are recommended cut zones on the vehicle. Determination of actual lift and cut points must be made by incident command based on the unique situational factors such as possible relocation of the hazards illustrated on the following pages as a result of impact events. These are only recommendations.

**CAUTION:** Review the “DO NOT CUT” illustrations that follow to be aware of the original placement of components that may pose electrical, thermal, kinetic or other hazards during extrication operations.

DO NOT CUT into any high voltage cables or components. Avoid cutting primary low voltage electrical components as illustrated below.

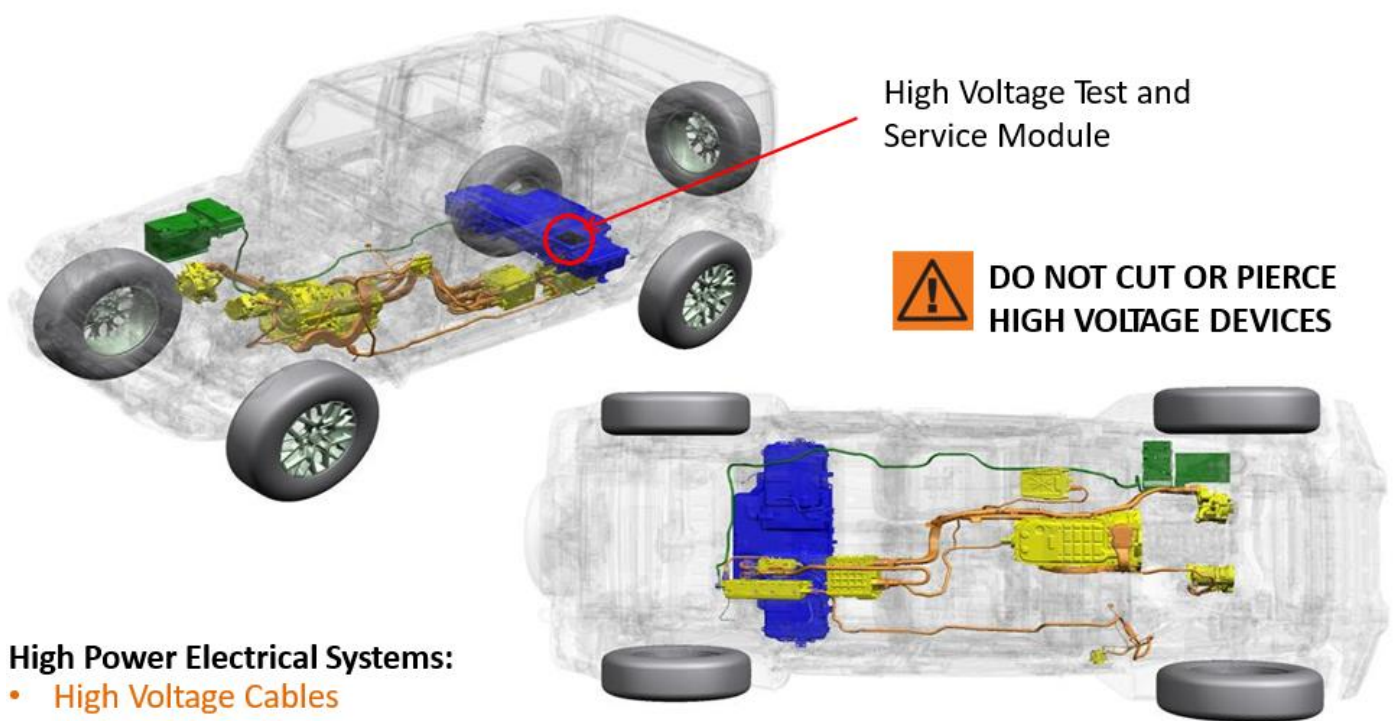
**High Power Electrical Systems:**

- High Voltage Cables
- High Voltage Components
- High Voltage Battery
- Low Voltage (12V) Battery and Cables



DO NOT CUT into any pressurized or combustible fluid component illustrated below.

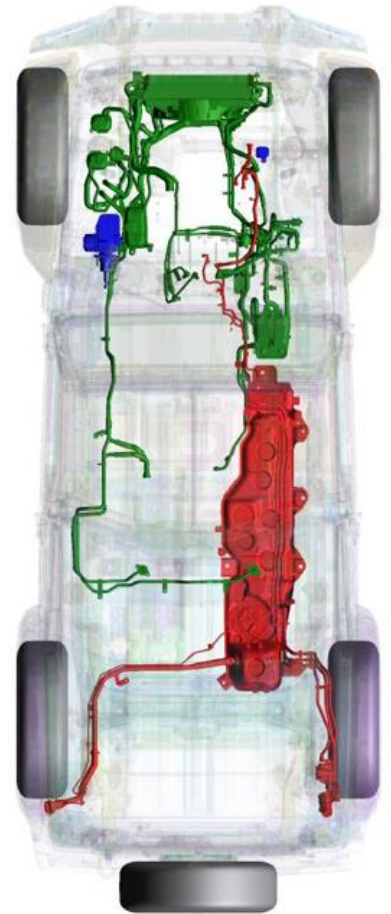
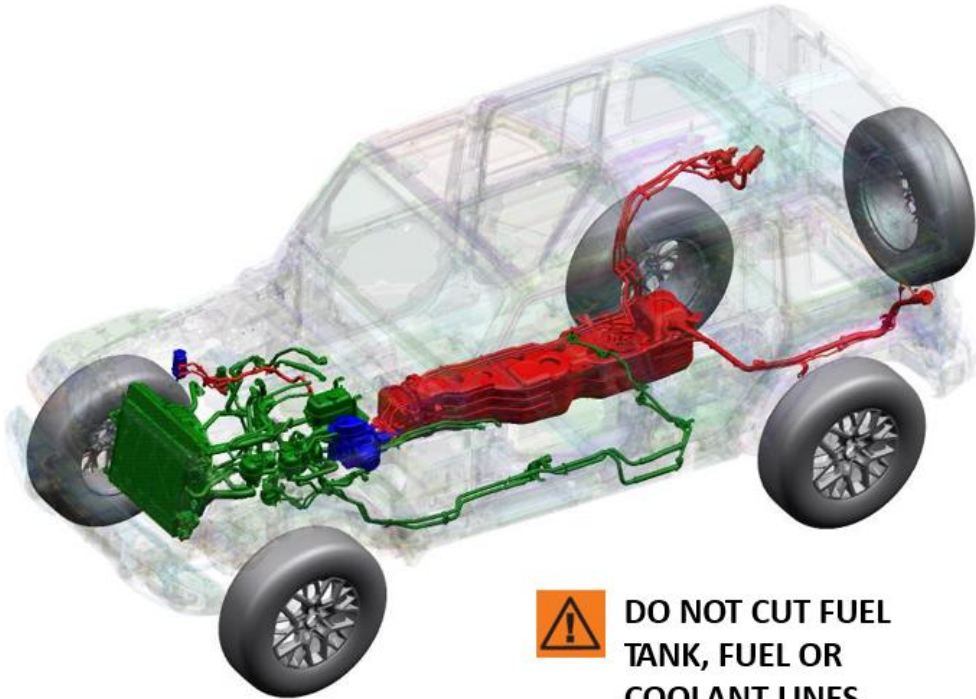

**DO NOT CUT FUEL TANK, FUEL OR COOLANT LINES**

**Fuel and other Fluid Systems:**

- Gasoline Fuel Tank and Fuel Lines
- Brake and Power Steering Reservoirs
- Radiator and Cooling System

DO NOT CUT into occupant restraint components. (Fabric belts only may be cut with a knife)

**Restraint Systems:**

- Front seat belts with pretensioning devices (horizontal cylinder below the belt spool)
- Driver and front passenger air bags, seat mounted side bolsters and side curtain air bags
- Impact sensors

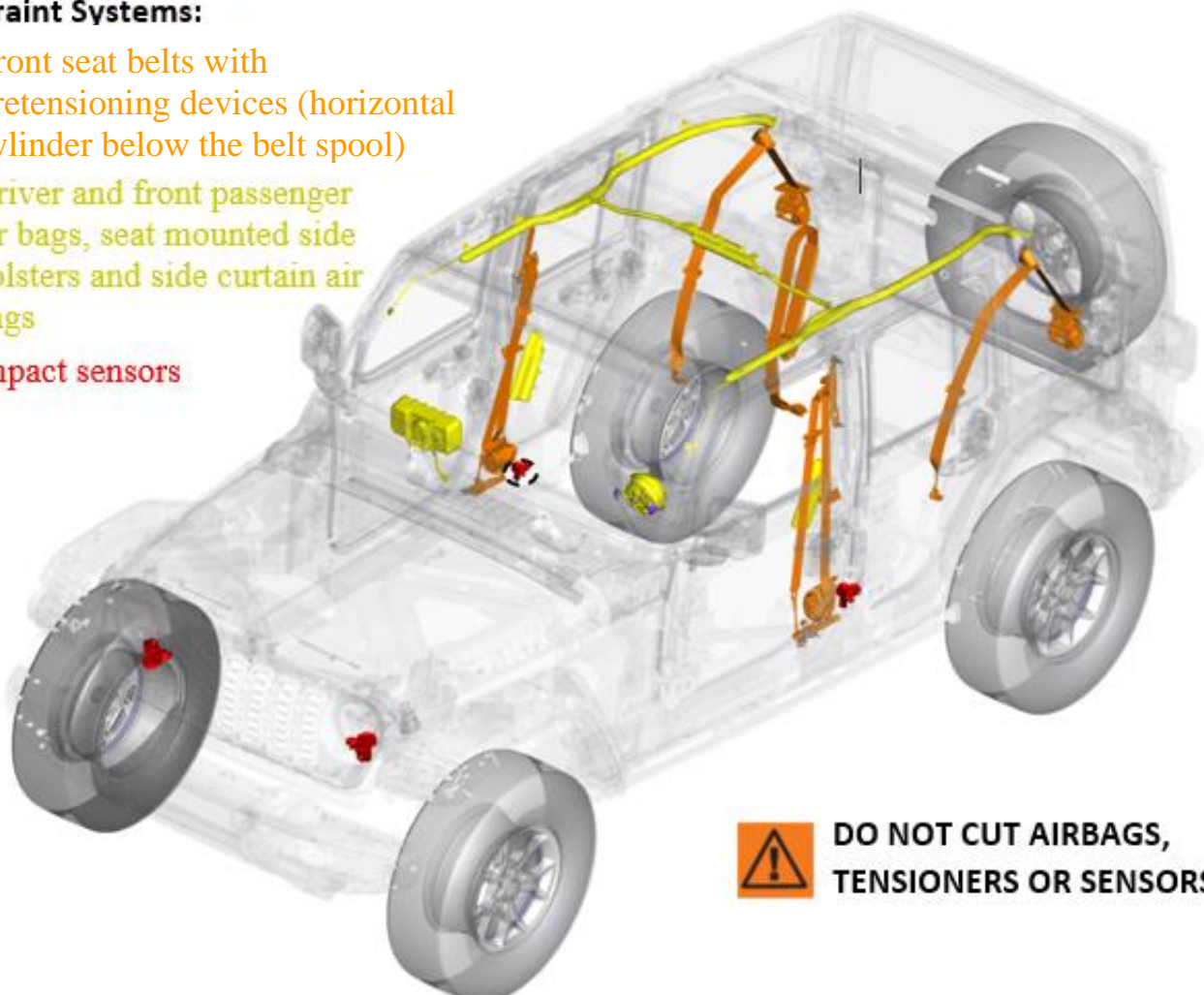

**DO NOT CUT AIRBAGS, TENSIONERS OR SENSORS**



Be advised that this vehicle includes select use of high-strength structural materials which may slow cutting and extrication efforts unless addressed with appropriate tools for such materials.

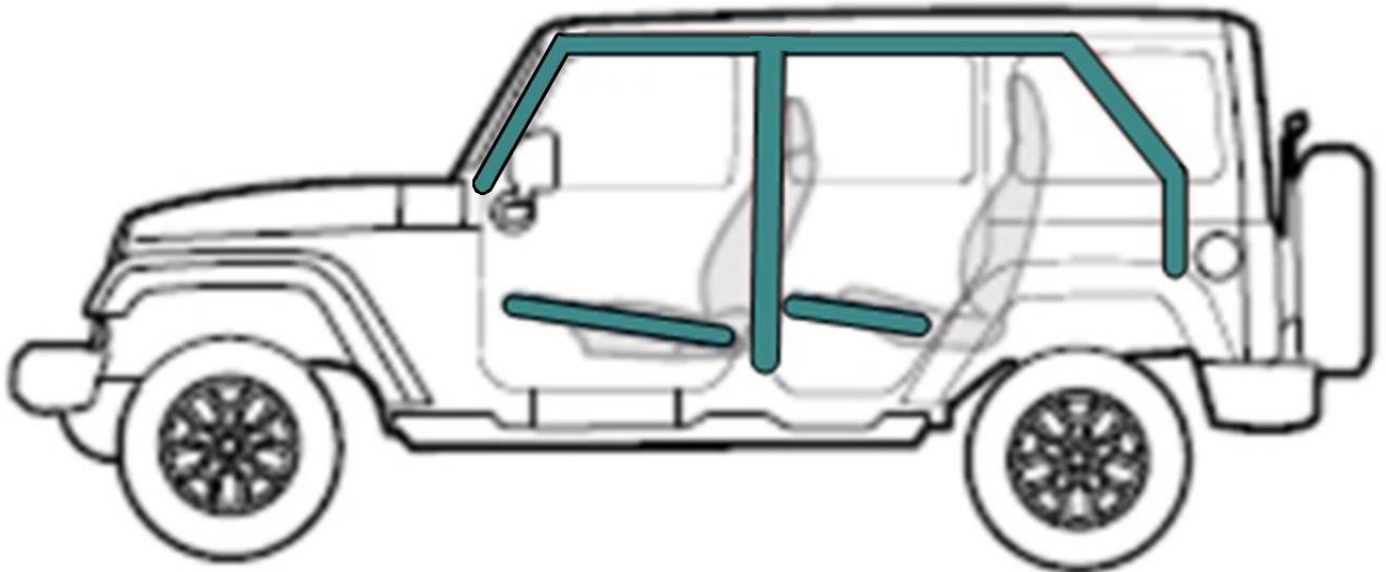

High strength steel components are illustrated in blue-green.

LAMINATED GLASS is utilized in the windshield and rear lift gate window

TEMPERED GLASS is utilized in all side windows

WARNING: Gaseous emissions from a thermally active damaged lithium-ion battery include hydrogen, which is explosive when mixed with oxygen in the air.



WARNING: Gaseous emissions from a thermally active lithium-ion battery include hydrogen fluoride which when combined with moisture in the human body forms an acid that can cause burns, respiratory distress and injury, blindness and/or death.



RECOMENDED: Immediately open all doors and remove all glass to maximize ventilation.

Under most circumstances, a high voltage battery at zero percent useable charge as shown on the dash still contains significant electrochemical energy. State of charge as displayed does not indicate any lessening of electrical shock or thermal progression potential.

**WARNING:** Do not puncture, cut, apply heat to, drop, crush, or attempt to attach electrical conductors to, any high voltage battery system or component, as injury or death may result.

**WARNING:** The specialized equipment necessary to safely discharge a high voltage battery pack is not available in the field presently. DO NOT attempt to improvise a means of discharge, as serious injury or death may result.

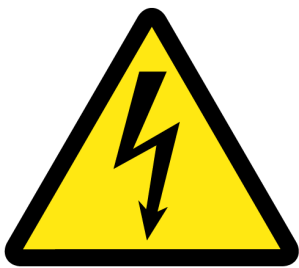

Discharging the Jeep Wrangler Hybrid 400-volt battery below the minimum operating voltage (which shows on the dash as a zero percent charge) will do permanent damage to the battery and requires bypassing safety mechanisms as well as specialized training. Therefore, the high voltage energy should be contained exclusively to within the battery pack in an incident response situation.

To contain high voltage energy within the battery pack, under most circumstances the procedures outlined in this guide will be sufficient. However, in rare cases, the isolation device internal to the battery system may have become damaged, in which case high voltage energy may only be contained within the battery pack by means of physically disconnecting all outputs from the battery pack, and covering those connectors. This process is not recommended unless guidance from Stellantis personnel with knowledge relating to disconnecting and securing the battery pack in the specific model involved is available to responders. Contact the Stellantis battery engineering team for guidance in this regard.

**WARNING:** Even after completion of these steps, it is possible for High Voltage to still remain accessible outside of the battery pack in the event of damage to the vehicle.



**RECOMENDED:** Personal Protective Equipment must be used by First Responders when addressing a damaged Jeep Wrangler 4Xe Hybrid. Treat all high voltage components as if energized at all times.

**WARNING:** 12 volt batteries contain sulfuric acid, which can cause burns and blindness on contact, and which may be lethal if ingested.



12 VOLT BATTERIES also contain trapped electrical energy of a low voltage potential. While these do not present a shock hazard, sparks and arcs of significant energy are possible, and can ignite volatile fuel vapors at an accident scene. To reduce risk of accidental ignition,



12V battery terminals may be stripped of all connections and covered as soon as safely possible following primary response activities.

PRESSURIZED FLUIDS: Exist in multiple systems within the Jeep Wrangler 4Xe Hybrid.

These systems include:

- Engine Cooling System and Radiator
- Power Electronics Cooling System
- Brake System
- Power Steering System
- Fuel System



RECOMMENDED: Avoid cutting into any tubing or components associated with these systems, as fluids may be ejected under pressure, and potentially at high temperature.

WARNING: Fuel is flammable, and hydraulic oil is combustible. These liquids may stick to or sink into clothing, acting as an accelerant if ignited.



The fuel system in the Jeep Wrangler Hybrid is pressurized to protect against air pollution.

WARNING: The fuel system is pressurized. If the system is ruptured, gasoline vapors will escape which have the potential to detonate if exposed to a source of ignition.



RECOMMENDED: Prior to cutting 12-volt power, depressurize the fuel system by pressing the fuel door release to the lower left of the steering wheel and wait 90 seconds for the door to open.

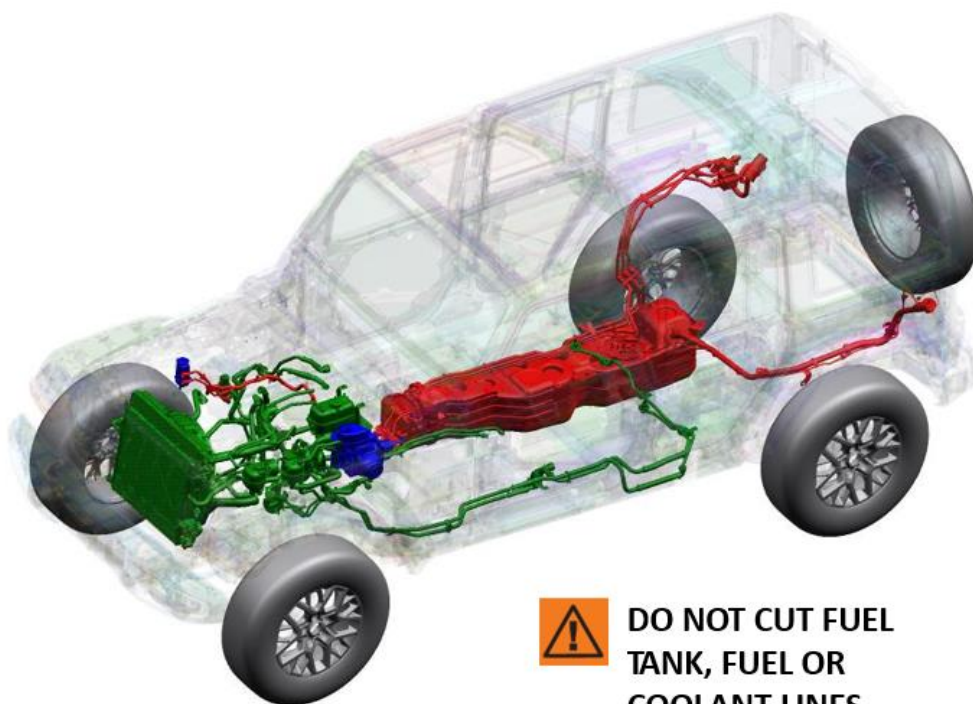

**DO NOT CUT FUEL TANK, FUEL OR COOLANT LINES**

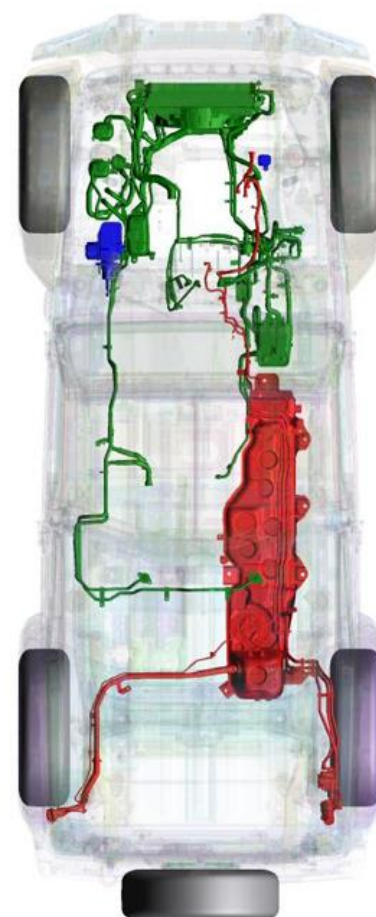

**Fuel and other Fluid Systems:**

- Gasoline Fuel Tank and Fuel Lines
- Brake and Power Steering Reservoirs
- Radiator and Cooling System



RESTRAINT SYSTEMS utilized in the Jeep Wrangler 4Xe Hybrid include two distinct sets of devices that contain “trapped energy” unless damaged or consumed. These are the seat belt retractors, and the systems that deploy various restraints upon impact.



Seat belt retractors utilize a wound spring that maintains a constant pull on the seat belt. Even when retracted, the spring still is under load. If damaged, it can shatter throwing sharp metal debris.

**WARNING:** Do not cut into seat belt retractor mechanisms, as injury or blindness may result.

Air bag and bolster actuators are, typically one-time-use, explosive devices used to rapidly inflate restraint devices on impact. Undeployed actuators can be triggered electrically by impact sensors, thermally, or sometimes by interaction with a cutting device passing into them.



Seatbelt Pretensioners employ a typically one-time-use explosive device to properly position the occupant for airbag deployment. These are a similar hazard to the airbag actuators, but can also propel metal components, or simply retract an inconveniently placed belt, with the associated risk of injury.



**WARNING:** Do not cut, puncture, heat, crush, or strike air bag or bolster inflators, impact sensors, or seatbelt pretensioners, as inadvertent detonation may result in injury or death.

#### Restraint Systems:

- Front seat belts with pretensioning devices (horizontal cylinder below the belt spool)
- Driver and front passenger air bags, seat mounted side bolsters and side curtain air bags
- Impact sensors

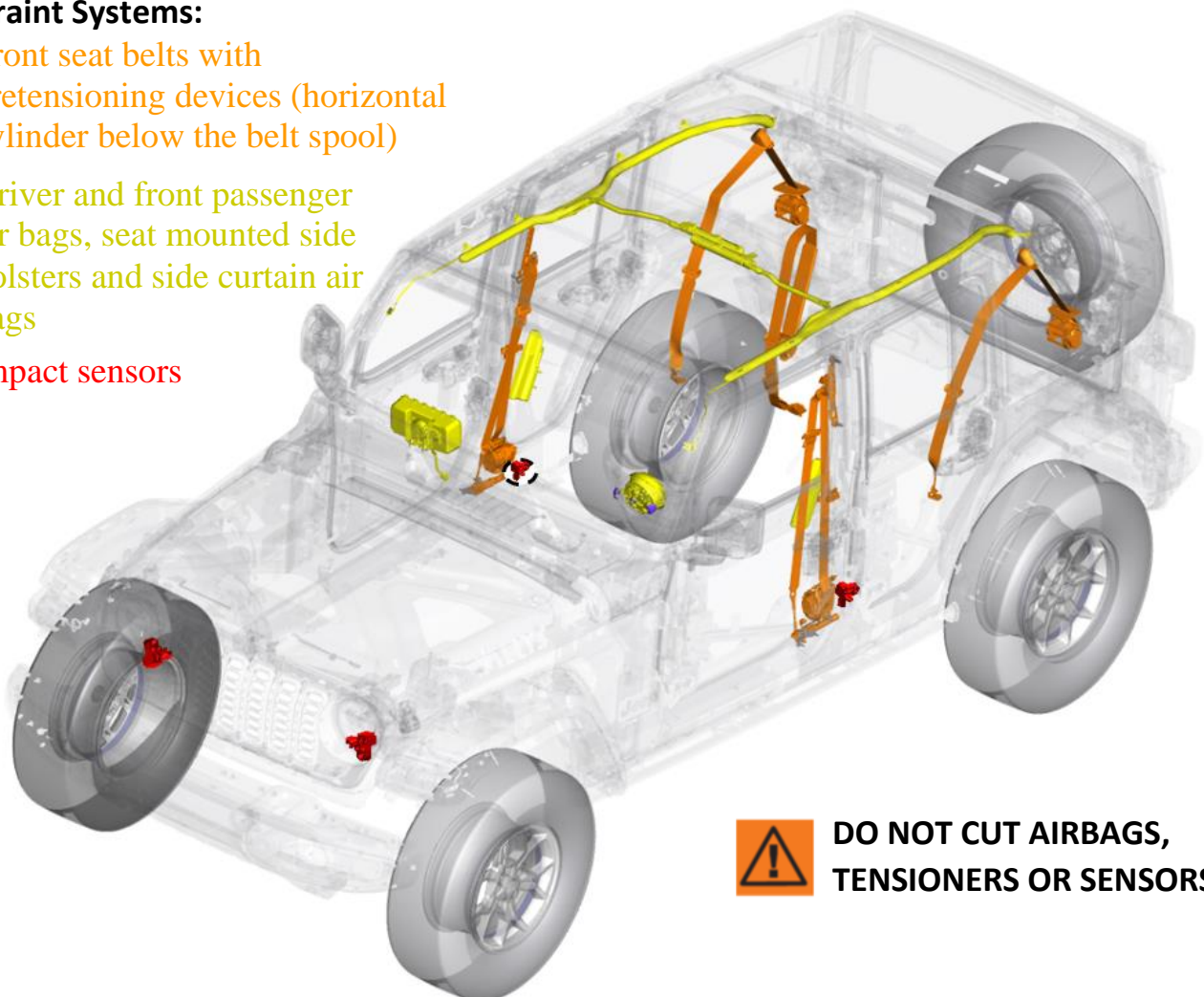

**DO NOT CUT AIRBAGS, TENSIONERS OR SENSORS**

 **Steering wheel, cross beam and rear swing gate**  
**Magnesium alloy**

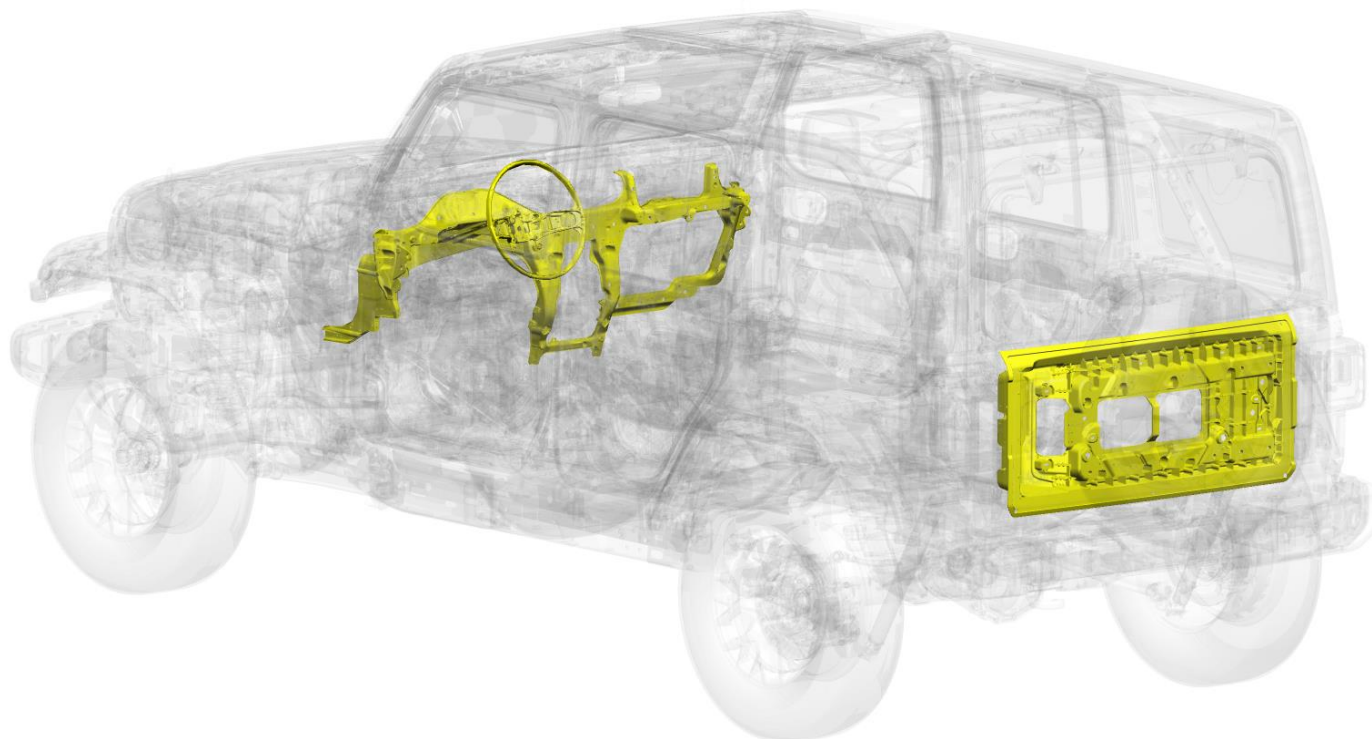
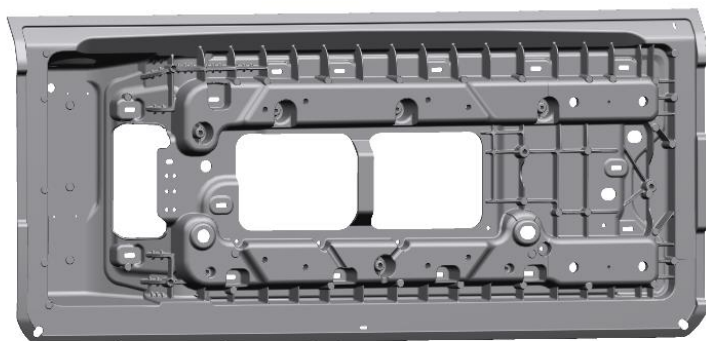
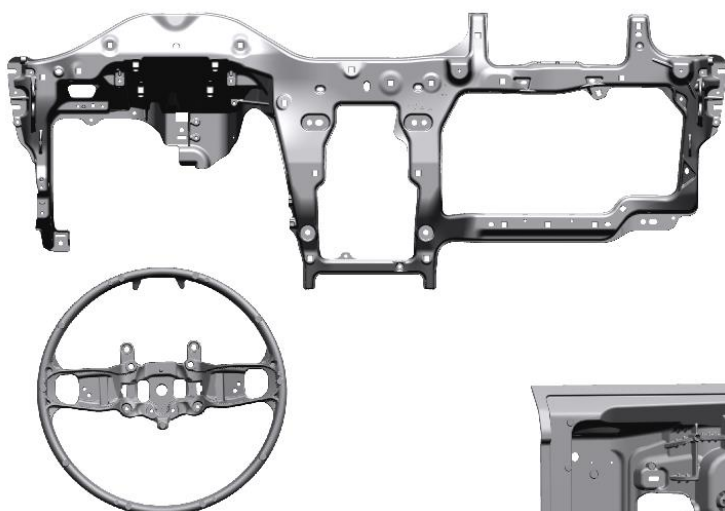

The Jeep Wrangler 4Xe Hybrid includes a high voltage lithium-ion battery system. As a result, special consideration must be given to extinguishing methods and practices.

### Fighting electrified driveline vehicle fires poses unique challenges.

- Chemical extinguishers and oxygen denial are not effective in these fires.
- Deluge with water delivered via fire hose at the maximum possible distance is the recommended practice to contain the fire and cool the reagents, minimizing risk of spread and risk of hazardous emissions. This should continue after extinguishment until the pack is cool.
- Ventilation of the passenger compartment, if occupied, is essential at the first sign of battery heating, smoke or fire.
- Batteries should be thermally assessed during initial operations and throughout rescue and remediation efforts.
- Damage, abuse, flooding or exposure to heat (such as from a vehicle fire) can initiate thermal reactions which will advance to a significant fire in lithium ion power systems.
- The Battery thermal reactions become self-sustaining at higher temperatures due to the emission of oxygen from certain constituents.
- Ongoing battery fire or heat production can facilitate the re-ignition of combustible automotive components above and adjacent to the pack.
- Lithium-ion automotive batteries can reignite due to ongoing reactions from internal heat.
- For any battery thermal event, NFPA recommends SCBA be required within fifty feet.

**WARNING:** Emissions from a thermally active lithium-ion battery include flammable hydrogen, and hydrogen fluoride which when combined with moisture in the human body forms an acid that can cause tissue burns, respiratory distress and injury, blindness and/or death.



**RECOMMENDED:** Application of large amounts of water should begin at the first signs of battery smoke as water may absorb some harmful toxic emissions in the smoke.

**RECOMMENDED:** Immediately open all doors and remove all glass to maximize ventilation.

**RECOMMENDED:** Rescue of persons at risk and containment of the fire with prevention of hazardous gas emissions should be the goals of fire-fighting efforts.

**RECOMMENDED:** An infrared thermometer should be used to assess the batteries thermal activity.

**WARNING:** Never cut, pierce or damage any high voltage component as serious injury or death may result.





A vehicle submerged or flooded with water can result in protective system failures.



Excessive heat and electrolysis may take place resulting in byproducts of hydrogen and oxygen. In salt water, chlorine is also a byproduct. These byproducts, trapped and concentrated by the passenger compartment, a garage, or other containment, may be in concentrations that could be explosive or corrosive and could have adverse effects on human health. Action should be taken to assure ventilation of a partially submerged vehicle and any space in which it is contained.



For a Wrangler 4Xe that is without physical damage (such as from an accident) the risk of electrical shock when submerged or flooded is not increased.



A vehicle with impact damage presents an increased electrical shock hazard risk. If HV is open to the environment you must stay away from damaged HV components.

**RECOMMENDED:** Responders must use proper Personal Protective Equipment when addressing a damaged Wrangler Hybrid vehicle.

## When removing an undamaged vehicle:

| Towing Condition | Wheels OFF the Ground | Four-Wheel Drive Models  |
|------------------|-----------------------|--|
| Flat Tow         | NONE                  | <b>See Instructions</b> <ul style="list-style-type: none"> <li>• Automatic transmission in PARK.</li> <li>• Manual transmission in gear (NOT in NEUTRAL [N]).</li> <li>• Transfer case in (N) Neutral.</li> <li>• Tow in forward direction.</li> </ul> |
| Dolly Tow        | Front                 | NOT ALLOWED  |
|                  | Rear                  | NOT ALLOWED  |
| On Trailer       | ALL                   | OK   |

**NOTE:**  
When towing your vehicle, always follow applicable state and provincial laws. Contact state and provincial Highway Safety offices for additional details.

Towing of an undamaged vehicle is permitted with all four wheels on the ground and the transmission in PARK, with the transfer case set to (N) neutral only. This vehicle is not designed to support “dolly tow” with only one set of wheels in contact with the road.

**RECOMMENDED:** Transporting of a Jeep Wrangler 4Xe Hybrid by flatbed truck or trailer is the preferred method.

**WARNING:** You or others could be injured or killed if you leave the vehicle unattended with the transfer case in the (N) Neutral position without first fully engaging the parking brake. The transfer case (N) Neutral position disengages both the front and rear driveshafts from the powertrain, and will allow the vehicle to roll, even if the automatic transmission is in PARK (or manual transmission is in gear). The parking brake should always be applied when the driver is not in the vehicle.



### For flat towing:

- The transmission must be placed in PARK, not (N) neutral.
- Secure the vehicle so that it cannot roll independent of the tow vehicle, such as with the temporary application of the parking brake.
- Do not use a fascia/bumper-mounted clamp-on tow bar on the vehicle. The bumper face bar will be damaged.
- Position the vehicle to be towed in the forward direction only.
- After completing the steps above, place the transfer case shift lever in the (N) neutral position to allow both axles to spin freely. SEE TRANSFER CASE NEUTRAL INSTRUCTIONS
- Only after verifying that the vehicle is secured to the tow vehicle, and that the tow vehicle will not move until driven, release the parking brake if set previously.

### For trailer or flat-bed truck transport (preferred):

- Secure the vehicle to the means by which it will be loaded onto the trailer or flatbed.
- Set the transmission to PARK and the transfer case shifter to (N) neutral. The vehicle will roll freely if the parking brake is released. SEE TRANSFER CASE NEUTRAL INSTRUCTIONS
- Roll the vehicle onto the trailer or flatbed.
- Secure the vehicle to the trailer or flatbed for transit.
- **WARNING:** After transit, the vehicle will roll freely until the transfer case is shifted out of (N) neutral. Do not unsecure without a means of preventing unintended motion.
- When the vehicle is back on the ground, set the transfer case to 2-Hi following the TRANSFER CASE NEUTRAL INSTRUCTIONS below.

## Transfer Case Neutral shifting Instructions:

**CAUTION:** It is necessary to follow these steps to be certain that the transfer case is fully in (N) Neutral before towing to prevent damage to internal parts.

Shifting the transfer case into (N) neutral:

1. Bring the vehicle to a complete stop on level ground.
2. Press and hold the brake pedal.
3. Shift the automatic transmission into NEUTRAL.
4. Turn the engine off.
5. Shift the transfer case lever into (N) Neutral.
6. Start the engine.
7. Shift the transmission into REVERSE.
8. Release the brake pedal for five seconds and ensure that there is no vehicle movement.
9. Repeat steps seven and eight with automatic transmission in DRIVE.
10. Turn the engine off.
11. Firmly apply the parking brake.
12. Shift the transmission into PARK (NOT in NEUTRAL).

**CAUTION:** Damage to the transmission may occur if the transmission is shifted into PARK with the transfer case in (N) Neutral and the engine running. With the transfer case in (N) Neutral ensure that the engine is OFF before shifting the transmission into PARK.

13. Attach the vehicle to the tow vehicle using a suitable tow bar.
14. Release the parking brake.

Shifting the transfer case out of (N) neutral:

1. Bring the vehicle to a complete stop, leaving it connected to the tow vehicle.
2. Firmly apply the parking brake.
3. Start the engine.
4. Press and hold the brake pedal.
5. Shift the transmission into NEUTRAL.
6. Turn the engine off.
7. Shift the transfer case lever to the desired position.

**NOTE:** When shifting the transfer case out of (N) Neutral, the engine should remain off to avoid gear clash.

8. Shift the automatic transmission into PARK, or place manual transmission in NEUTRAL.
9. Release the brake pedal.
10. Disconnect vehicle from the tow vehicle.
11. Start the engine.
12. Press and hold the brake pedal.
13. Release the parking brake.
14. Shift the transmission into gear, release the brake pedal (and clutch pedal on manual transmissions), and check that the vehicle operates normally.

Towing this vehicle in violation of the above requirements can cause severe transmission and/or transfer case damage. Damage from improper towing is not covered under the New Vehicle Limited Warranty.

**WARNING:** Do not “dolly tow” (only one axle on the ground) this vehicle as severe damage will result and could lead to an accident while under tow.



**When removing a damaged vehicle** and remediating the area after an incident:

**FLUIDS:** The Jeep Wrangler Hybrid battery is a “non-spillable” qualifying architecture. Battery electrolyte remains trapped in the internal elements of the electrical cells. Liquid spilled from a high voltage battery pack is primarily engine coolant.

Collect spilled fluids for disposal as follows:

- Collect spilled engine coolant and any coolant from electronic systems in the normal manner for spilled glycol/water mix.
- Collect spilled engine and hydraulic oil with absorbent material, and use detergents to recover from masonry. Collect contaminated ground for disposal in accordance with local requirements as applicable.
- Collect spilled gasoline in the same manner as oils, but employ precautions for the management of flammable and explosive vapors.
- Collect spilled 12 V battery electrolyte with an absorbent that neutralizes the highly acidic sulfuric acid electrolyte. Do not handle 12 V battery electrolyte, or materials contaminated with 12 V battery electrolyte without chemically resistant protection.



**BATTERY PACK DEBRIS:** In the event of significant damage to and fragmentation of the high voltage battery pack, all debris should be collected and disposed of. While not classified as a hazardous waste, skin contact with battery pack internal elements is to be avoided.

**POST-INCIDENT DELIVERY TO SERVICE:** If air bags have deployed, the vehicle cannot be driven again until repaired, as air bag protection will not be available to occupants in the event of a collision. After any collision, the vehicle should be taken to an authorized dealer immediately.



**VEHICLE MOVEMENT:** The rotation of the wheels at more than creep speeds can cause the generation of electrical energy in damaged vehicles. This may reach high voltage potentials. Additionally, in damaged systems with remaining propulsion ability, movement of the wheels could trigger a driveline response and result in unexpected movement of the vehicle.  
**DO NOT PUSH BY HAND.**

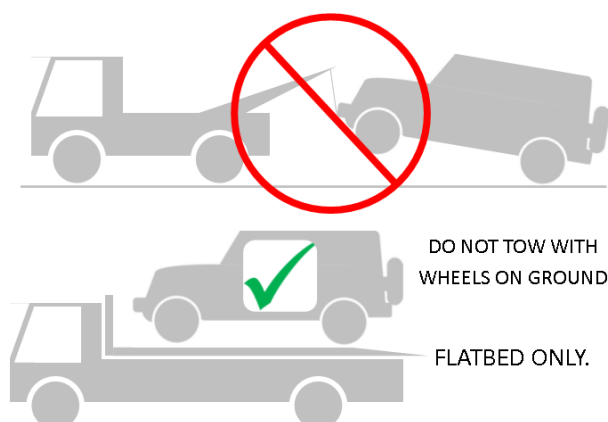

**PREPARATION FOR TOWING:** The relocation of a damaged vehicle must be by means of a trailer, flatbed or similar conveyance that will not allow rotation of the drive wheels. For loading, ideally drag the drive wheels in a locked position, or if drive wheels must rotate, move the car at speeds of no more than 12 feet per minute.

**WARNING:** During preparation, transport and storage, isolation and observation of the vehicle, particularly the high voltage battery pack, is necessary to watch for, and react to, any signs of delayed ignition or re-ignition of the battery pack.

**RECOMMENDED:** An infrared thermometer should be used to assess the batteries thermal activity.

## Damaged vehicle towing instructions:

- Secure the vehicle to the means by which it will be loaded onto the trailer or flatbed.
- Set the transmission to PARK and the transfer case shifter to any setting other than (N) neutral. Set the parking brake. This will lock the wheels in place and require dragging the vehicle to load.
- Drag the vehicle onto the trailer or flatbed.
- Secure the vehicle to the trailer or flatbed for transit.
- **WARNING: If the transfer case or transmission were left in (N) neutral, the vehicle will roll freely when not secured. Do not unsecure without a means of preventing unintended motion.**

If circumstances require that the damaged vehicle be allowed to roll, such must be kept to a minimum and at creep speeds only. If 12-volt power is disabled, and the vehicle is in PARK, it will be necessary to follow these steps:

1. Firmly apply the parking brake.
2. Using a small screwdriver or similar tool, remove the manual park release cover, located above the gear selector, to access the release tether strap.
3. Fish the tether strap up through the opening in the console base.
4. Press and maintain firm pressure on the brake pedal.
5. Pull the tether strap up and to the left until the release lever locks into place in the vertical position. The vehicle is now out of PARK (P) and can be moved. Release the parking brake only when the vehicle is securely connected to a tow vehicle.

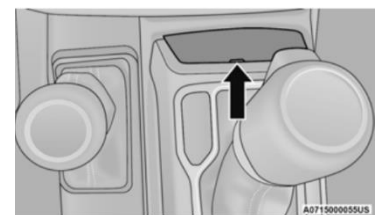

Manual Park Release Cover

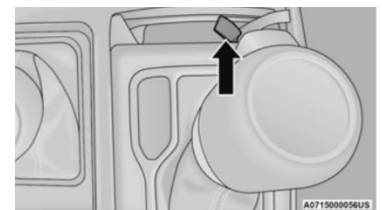

Tether Strap

**WARNING: Always secure the vehicle by fully applying the parking brake before activating the Manual Park Release. In addition, you should be seated in the driver's seat with your foot firmly on the brake pedal when activating the Manual Park Release. Activating the Manual Park Release will allow the vehicle to roll away if it is not secured by the parking brake, or by proper connection to a tow vehicle. Activating the Manual Park Release on an unsecured vehicle could lead to serious injury or death for those in or around the vehicle.**

**POST-INCIDENT HANDLING:**

Following initial response, certain actions and precautions are necessary. If air bags have deployed, the vehicle cannot be driven again until repaired, as air bag protection will not be available to occupants in the event of a collision. After any collision, the vehicle should be taken to an authorized dealer immediately.

While the Wrangler 4Xe HV battery is designed for safety, industry-wide experience has demonstrated that the unlikely possibility of delayed ignition or re-ignition of a damaged battery must be considered in post-incident handling. Any battery exposed to accident forces sufficient to deploy air bags or to a vehicle fire requires special precautions until verified as undamaged.

- The vehicle or battery pack must not be stored inside a structure, occupied or otherwise.
- Adequate ventilation must be present at the storage location to prevent buildup of any outgassing.
- Batteries to be recycled must be shipped in accordance with regulations governing the transport of damaged lithium-ion batteries (and never by air).
- Thermal monitoring of any damaged, flooded or burned battery should be performed during storage.
- The manual battery High Voltage Test and Service Module cover must not be reinstalled by other than an authorized technician.
- The High Voltage Test and Service Module opening must be covered/sealed to prevent water or debris entering the battery.
- The battery pack in this vehicle uses non-spillable lithium-ion cells, and it is unlikely that electrolyte, which is clear, will escape from the pack in the event of damage. Liquid emissions from damaged packs are typically colored battery coolant, which should be addressed in the same manner as spilled engine coolant.
- Do not apply chemical neutralizers used for other battery types to Lithium-ion battery components, or take any other action which could result in battery cell contents being aerosolized.

Do not ingest, inhale, or make bare skin contact with any internal material from the battery cells. In the event of accidental contact of this nature, wash exposed skin thoroughly with soap and water for at least 5 minutes and seek medical attention. In the event of ingestion, seek emergency medical care immediately.

Stellantis / FCA US Customer Center: (877) 426-5337

Stellantis / FCA Canada Customer Center: (800) 465-2001 (English) (800) 387-9983 (French)

Stellantis / FCA Mexico Customer Center: +(52) 55 50817568

Stellantis / FCA within Mexico City only: (800) 505-1300

Stellantis / FCA Caribbean Customer Center: (877) 426-5337

Service Manuals are available in the US and Canada from Tech Authority: (800) 890-4038.



The Jeep Wrangler 4Xe Hybrid is designed and built with a focus on protecting both our customers and the environment. Nonetheless, when vehicles are damaged or catch fire, a number of substances are released which may be harmful to life or the environment. Obtaining material safety information in accordance with your organization's practices may be useful with regard to:

|                 |                  |                        |                  |
|-----------------|------------------|------------------------|------------------|
| Gasoline        | Lead             | Hydrogen               | Methyl Carbonate |
| Ethanol         | Sulfuric Acid    | Hydrogen Fluoride      | Ethyl Carbonate  |
| Ethylene Glycol | Hydrogen Sulfate | Hydrofluoric Acid      |                  |
| Hydraulic oils  | Vinyl Chloride   | Benzene                |                  |
| Motor oil       | Chlorine gas     | Pentafluoral Phosphate |                  |

**RECOMMENDED:** The use of SCBA within 50 feet of any vehicle event involving a thermally active lithium-ion battery pack, including following initial extinguishing activity, is recommended by NFPA as well as by Stellantis.

|  |                           |  |                                    |  |  |
|--|---------------------------|--|------------------------------------|--|--|
|  | GASOLINE-ELECTRIC VEHICLE |  | IMPORTANT INFORMATION              |  | ELECTRICAL SHOCK HAZARD                      |
|  | RISK OF FIRE              |  | RISK OF EXPLOSION                  |  | HARMFUL OR LETHAL TO HUMAN HEALTH            |
|  | CORROSIVE SUBSTANCE       |  | RISK OF INJURY                     |  | LITHIUM-ION BATTERY —HANDLE APPROPRIATELY    |
|  | DO NOT PUSH VEHICLE       |  | RELOCATE KEY FOB AWAY FROM VEHICLE |  | RISK OF THERMAL ACTIVITY FROM BATTERY SYSTEM |
|  | FLATBED/TRAILER TOW ONLY  |  | DO NOT TOW WITH WHEELS ON GROUND   |  |  |

3-Dimensional illustrations utilized in this guide are constructed as if the bulk of the vehicle is semi-transparent, with the components of interest shown in solid color.

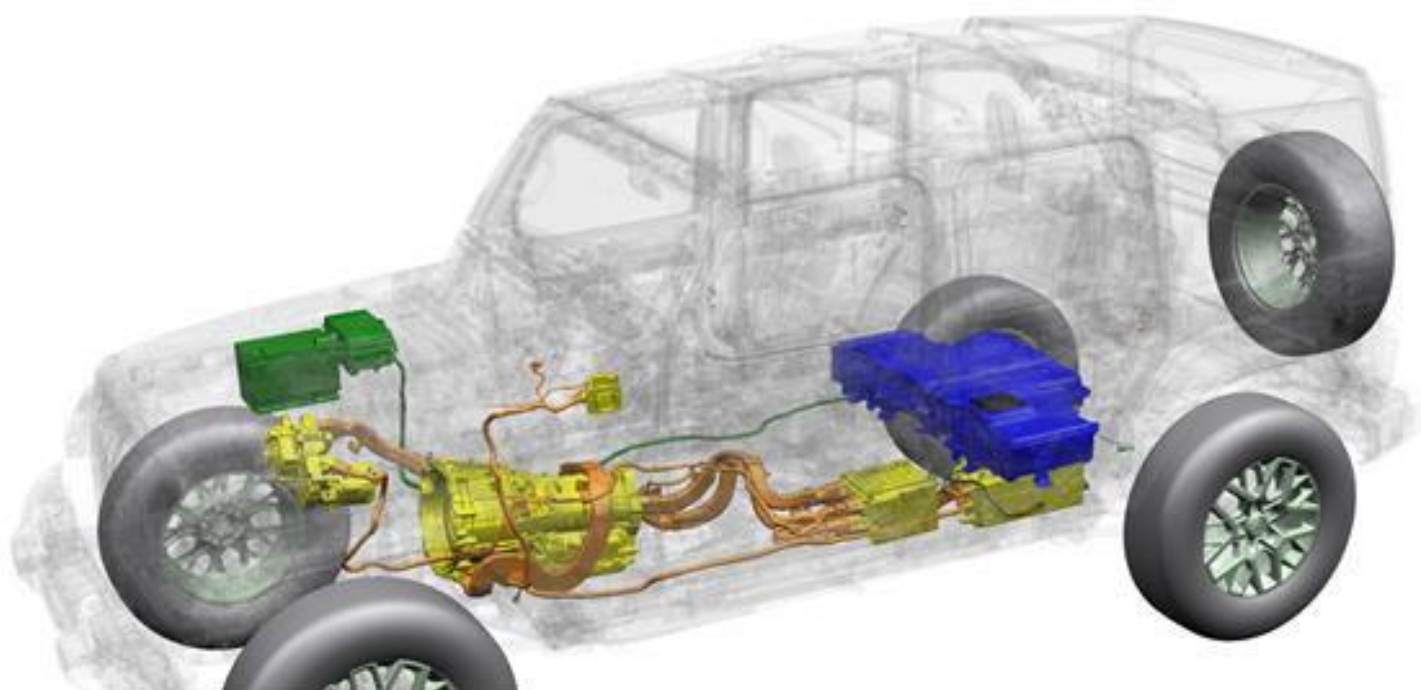

These illustrations are intended to convey the location of the components of interest within the 3-dimensional form of the vehicle to aid responders in estimating where those components lie within the vehicle with which they are presented – recognizing that it may be in a somewhat different form.